



LET'S BUILD A BETTER FUTURE



ALUPROF SYSTEMS OVERVIEW  
Edition 2023

Publisher ALUPROF SA  
[www.aluprof.com](http://www.aluprof.com)

8	<b>FAÇADE SYSTEMS</b>
10	<b>MB-TT50 mullion-transom wall</b>
	<b>MB-SR50N HI+ mullion-transom wall</b>
	MB-SR50N, MB-SR50N HI mullion-transom wall
	MB-SR50N EFEKT silicon sealed façade
	MB-SR50N IW façade with integrated window
	MB-SR50N A Add-on construction on timber and steel subframe
	MB-SR50N OW Parallel window
	MB-SR50N RW, MB-RW roof window
14	<b>MB-SR50N EI, MB-SR50N EI EFFEKT fire rated system of EI 30, EI 60</b>
16	<b>MB-SR60N, MB-SR60N HI+ mullion and transom curtain wall with improved thermal insulation</b>
18	<b>MB-SE75, MB-SE75 HI unitized façade</b>
20	<b>EXTRABOND rain screen facade system</b>
22	<b>MB-SR50N ZS mullion and transom curtain wall system integrated with SkyFlow venetian blinds</b>
24	<b>SKYFLOW exterior venetian blinds</b>
26	<b>SKYROLL external roller blinds</b>
28	<b>MB-OPENSKY 120 pergola system</b>
30	<b>MB-OPENSKY 140 pergola system</b>
32	<b>MB-SUNPROF brise soleil system</b>
	<b>WINDOW AND DOOR SYSTEMS</b>
34	<b>MB-SUNSHADES shutter system</b>
36	<b>MB-104 PASSIVE Aero, MB-104 PASSIVE SI window &amp; door systems that provide the highest thermal insulation</b>
38	<b>MB-86N ST, MB-86N SI window and door system</b>
	MB-86US window with concealed vent
	MB-86 CASEMENT outward opening windows
40	<b>MB-86 FOLD LINE HD folding door</b>
42	<b>PANEL DOOR – MB-70, MB-79N, MB-86N &amp; MB-104 PASSIVE – based system</b>
44	<b>MB-79N E, MB-79N ST, MB-79N SI, MB-79N CASEMENT window and door system</b>
46	<b>MB-70, MB-70HI window and door system</b>
	MB-70US, MB-70US HI window with concealed vent
	MB-70SG structurally glazed window with concealed vent
	MB-70 INDUSTRIAL system for historic buildings
	MB-70 CASEMENT outward opening windows
	MB-70CW window-based cold-warm façade
50	<b>MB-FERROLINE window system with slim profiles</b>
52	<b>MB-SLIMLINE window system with slim profiles</b>
54	<b>MB-SKYLINE TYPE R panoramic sliding door with concealed frame</b>
56	<b>MB-SKYLINE panoramic sliding door with concealed frame</b>
58	<b>MB-77HS lift and slide door</b>
60	<b>MB-59HS lift and slide door</b>
62	<b>MB-59 SLIDE sliding door</b>
64	<b>MB-59 SLIDE GALANDAGE sliding french door</b>
66	<b>MB-78EI fire rated doors and wall partitions of EI 15 – EI 90</b>
	MB-78EI DPA automatic fire rated sliding door
66	<b>MB-118EI fire rated wall partitions of EI 120</b>
68	<b>MB-78EI silicone jointed glazed walls EI 60</b>
70	<b>MB-86EI fire rated windows, doors and wall partitions of EI 30</b>
72	<b>MB-60EI fire rated system with door EI 15 – EI 30</b>
74	<b>GLASSPROF EI fire-resistant glass EI 30 – EI 90</b>
76	<b>MB-60, MB-60HI window and door system</b>
	MB-60US, MB-60US HI window with concealed vent
	MB-60E, MB-60E HI economic door
	MB-60 PIVOT window
	MB-60EF, MB-60EF HI window in MB-SR50 EFEKT façade
80	<b>MB-59S HI window and door system</b>
	MB-59S window and door system
	MB-59S CASEMENT outward opening windows
	MB-59SE economic door
	MB-59S PIVOT window
84	<b>MB-HARMONY interior glass partitions</b>
86	<b>MB-HARMONY DUO interior glass partitions</b>
88	<b>MB-EXPO, MB-EXPO MOBILE partitioning system</b>
90	<b>MB-80 OFFICE partition walling system</b>
92	<b>MB-45 OFFICE partitioning system</b>
94	<b>MB-45 window and door system</b>
	MB-45 smoke-proof door
	MB-45S groove-fitted door
	MB-45EW fire partition walls with door EW30
96	<b>MB-GLASS BARRIER external Juliet balcony</b>
98	<b>MB-SLIDER WINDOW sliding window</b>
100	<b>Sliding door</b>
	MB-SLIDE, MB-SLIDE ST sliding windows and doors
	MB-DPA sliding doors, automatic and manual
102	<b>MB-INSTALLATION SOLUTION a warm and tight installation system</b>
	<b>BESPOKE SOLUTIONS</b>
104	<b>MB-SE85 SG structural unitised façade</b>
104	<b>MB-SE80 SG structural unitised façade</b>
105	<b>MB-70US HI window with a concealed sash</b>
105	<b>MB-78EI fire rated system</b>

# ALUPROF – EVERYTHING’S UNDER CONTROL

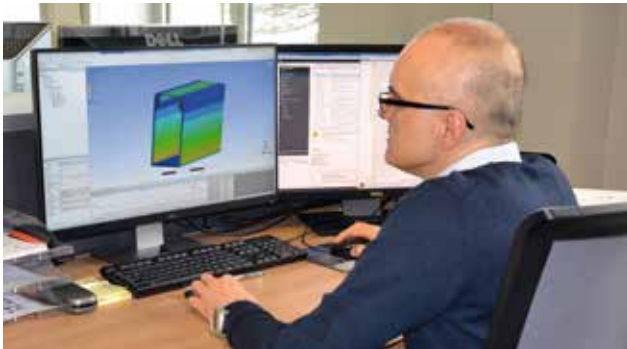

## RESEARCH & DEVELOPMENT

In its activities, Aluprof S.A. pursues the continuous improvement in the quality of products. They meet and exceed the requirements of the European standards for the quality of alloys, manufacturing tolerance and strength properties.

The know-how of the enterprise is its engineering ideas. The world class designers and engineers work on state-of-the-art innovative and technologically advanced solutions. The designed systems meet the needs of the market and help to achieve the architect's visions, and they also significantly contribute to the development of the aluminium structure branch.

The high quality and success of our systems is a result of the creative work of the design department. Development of new window and door, façade and roller blind system involves our customers, taking into consideration their ideas, concerns and suggestions.



## TECHNICAL SUPPORT

The in house technical team provides our business partners with support and advice in solving a wide range of problems, as well as training and explaining new systems and construction/calculation software.

The responsibility of the department is to provide advice and support in system selections, material valuations, specifications, technical drawings, as well as the design of details and calculations. The department’s mission is also to promote Aluprof’s solutions among architects, support and advise them in design and construction processes, as well as provide any technical support in solving problems.

The specialists working in the department are at the disposal of architects and manufacturers of aluminium joinery. If you have questions or issues the team will be more than happy to help find a resolution for your problem.

For contact details, visit [www.aluprof.eu](http://www.aluprof.eu) and click the tab Contact.



## PRODUCTION PROCESS

As we extrude our own profiles with the company group, Kety Capital, we are able to provide a competitive price, flexibility and very good lead times.

Aluprof has lines for automatic insulation of aluminium profiles using a thermal break. “Warm” profiles manufactured like this are the basic component of window and door systems offered by the company.

Thermally insulated profiles are also made as a part of service provision. In addition to standard profiles, customers can also order the dual colour ones, i.e. two different paint colours, paint and anode, anode and wood-grain coating etc.





## CURVED PROFILES

- bending profiles according to drawings and templates
- possibility to construct curved structures using raw, painted and wood-grain coated profiles

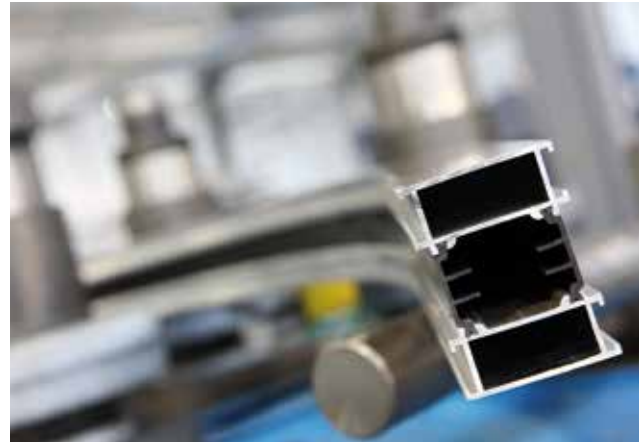

## POWDER COATING

### ADDITIONAL SERVICES

In both its plants, Aluprof has modern powder paint shops at its disposal. There are high-duty, fully automatic lines equipped with quick colour change spray booths. Thanks to the additional manual painting line, the company is able to quickly adapt to the requirements of its clients, depending on the scale of the order and its completion date. The company focuses on environmental friendly solutions, using non-toxic preparations and chromium-free aluminium treatment. The sandwich-type booth, as well as the powder supply and recovery system, allows the effective use of varnish and a quick colour change.

The entire powder coating process is computer-controlled, which guarantees the Consistency and conformity of painting parameters, including coating thickness. The effectiveness of control over painting parameters is confirmed by the certificates from the Qualicoat organisation and the supplier of IGP powder coating systems.

The offer includes:

- any types of powder varnishes in the entire RAL colour palette, NCS and paints with extended warranty,
- wood-like DECORAL surfaces,
- powder coated sheets of 1250×3000 mm,
- two-layer system (primer + topcoat paint) recommended in the “swimming-pool, seaside” environment, and preanode+paint.

The output of Aluprof's paint shops is 7 million m<sup>2</sup> per year. Maximum overall dimensions: W 7200 mm; H 500 mm; weight of material hung on tag up to 300 kg.



## ANODISING

Aluprof's offer includes anodised profiles. They are also available with a brushing and shot blasting effect. Quality confirmed by Qualanod certificate.

**TESTING FACILITY**

Aluprof has its own independent Centre For Research & Innovation which carries out testing according to the European (EN) and American (ASTM, AAMA) standards in collaboration with numerous notified bodies.

The laboratory is equipped with one of the largest chambers in Europe for testing curtain walls with dimensions of 10x10 m and with a testing chamber (6.5x6 m) for testing windows, doors, façades and external roller shutters for air permeability, water tightness, and wind load. The chambers allow for seismic & thermal cycle testing while the modular furnace is fit for fire-resistant testing (5x5m).

The Laboratory carries out, i.a. certification and periodic tests and offers good prices against other testing laboratories in Poland which is a great competitive advantage.

The Laboratory has signed an agreement on testing with the most prestigious research institute in Europe – IFT Rosenheim, and is entitled to perform tests which are subsequently certified by IFT Rosenheim.

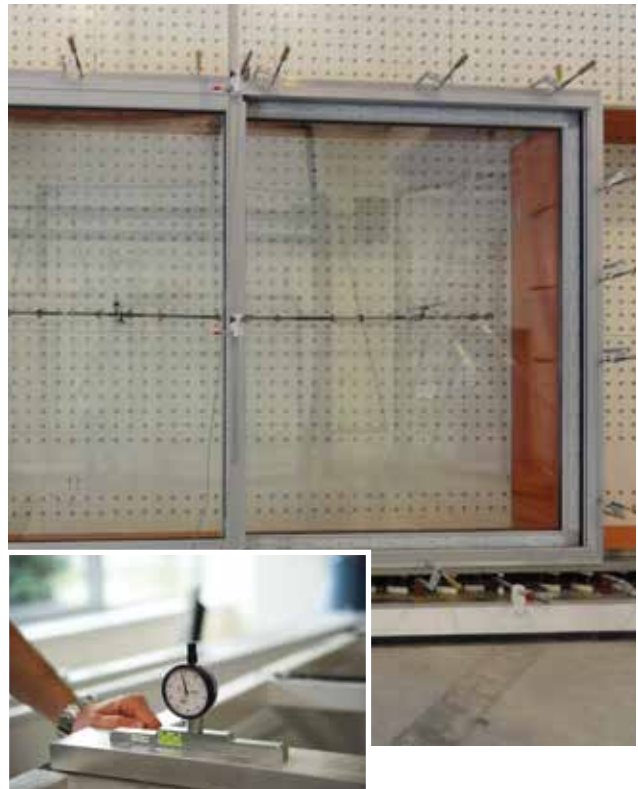

**TRAINING CENTRE**

Prototype room, training centre, service group – we provide our business partners with technological support and technical advice in solving technical problems both at Aluprof's headquarters and on site at the customer's location.

The service group offers full support to manufacturers, as a result of which they get to know the secrets of manufacture and prefabrication of components so that the entire production line can be fully optimised and the production efficiency improved.

The service group visits all the manufacturers cooperating with Aluprof who need help in the prefabrication of Aluprof systems, and even the servicing for fixture mounting.

All the new solutions to be implemented by Aluprof are first made on site in the prototype room and then the customer is trained in the precise manufacture of complete products based on pre-configured system components. The on-site service at the customers' location offers higher training opportunities, as the employees work at their workplaces and with their tools. During such a visit, the co-operators are given specific information on the optimum workshop organisation and precisely defined rules of joinery manufacture.

Thanks to such cooperation, customers obtain higher productivity, due to the elimination of errors, inspection of machines or simply normal counselling in prefabrication, which ensures failure-free operation. The service group is characterised by flexibility and a very fast response to any reported service demands.

Aluprof's service group is a qualified and flexible crew.



Certificate of training at Aluprof SA

## TOOLING

The offer of Aluprof SA includes the full range of tooling which is necessary for window, door and curtain wall fabrication.

Aluprof's modern tooling ensures high quality. Long-standing experience in this branch has been conducive to the designing of easy-to-operate equipment, which is at the same time very advanced from the technological point of view. Thus, the equipment will allow you to save time and increase your productivity. The offer also includes multi-functional devices that can be used in several different operations.

The tooling is characterised by simple maintenance and part replacement. Some of the devices can be used in multiple systems, which, to a large extent, eliminates the additional costs related to the commencement of production of another system. Aluprof's instrumentation also means the warranty of safety when performing treatments.

The list of required tooling is provided in the production catalogues, available in the section "Tooling".



## SOFTWARE

TO MAKE IT EASIER for customers to make aluminium structures in Aluprof systems, we offer specialist computer programs.

**MB-CAD** – specialist calculation software to facilitate and accelerate the works related to design, cost estimation and production set-up of aluminium structures. It enables the fast creation of offers for the customer, the generation of material summaries, and the creation of production lists and cut-out lists.

**Uni\_Link** – is a versatile and unique software for CNC machines used for aluminium, steel and PVC profile treatment. All the production lists prepared with the Uni\_Link platform can be used by every machine in the industry. In addition to controllers for all the machines, Uni\_Link has also prepared a platform for connection with different construction and calculation programs.

Thus, we offer our customers complete automation. Instead of manual machine programming at the workshop, the program enables the controlling all of the machines by importing data from any calculation program.

**LOGICAL** – computer program supplied by Orgadata. This application controls CNC treatment centres and is integrated with the financial and accounting department.

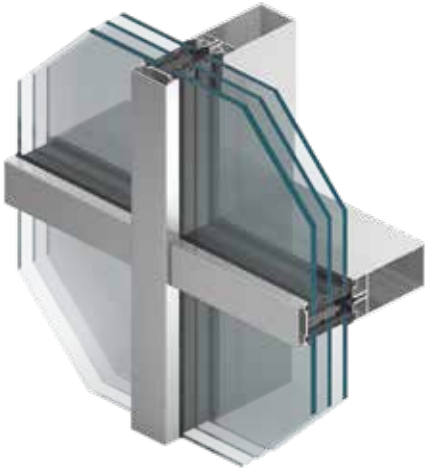

## FAÇADE SYSTEMS **MB-TT50**

To a large extent, the energy efficiency of an entire building depends on the thermal insulation of its façade. In this respect, the ALUPROF **MB-TT50** is capable of meeting the expectations of architects and developers working on the most contemporary of buildings. The system represents an entirely new approach to the construction of aluminium profiles and the accessories responsible for the airtightness and thermal insulation of the joints. The result is a façade which provides the building with a high level of protection against heat loss. The **MB-TT50** can be used to build curtain and infill walls, roofs and spatial structures. It offers a wide range of possibilities for shaping a development and a large selection of operable façade elements. There are various types of windows and doors, including the ALUPROF MB-SR50N roof window, windows integrated into the façade and the MB-SR50N OW tilt and parallel-opening windows.

**$U_f$  from 0.5 W/(m<sup>2</sup>K)**

**CWCT certified**



**ALCHEMIA**

Location: Gdańsk / Poland / Design: APA Wojciechowski



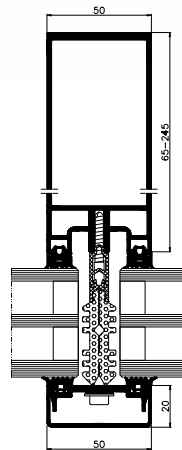
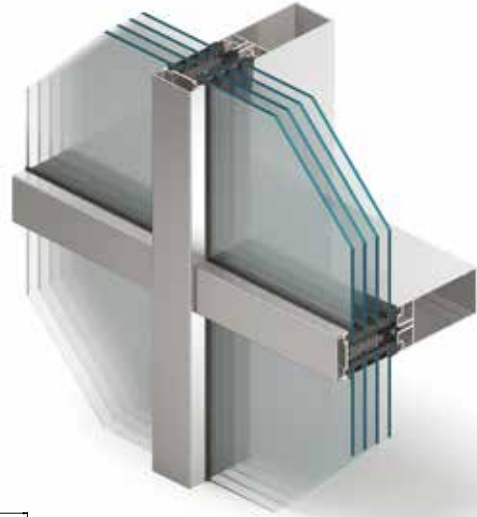
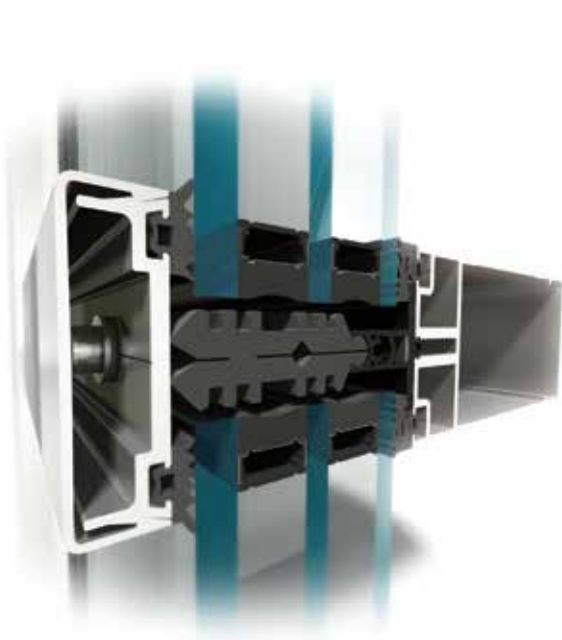

mullion – cross-section

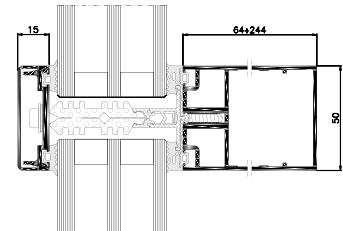

transom – cross-section

## FEATURES AND BENEFITS

- certified highest class A+ by the PHI Darmstadt Institute, MB-TT50 system can be successfully used in all passive buildings
- profile shapes are adjusted to current trends in architecture and enables flushing of mullion-transom profiles from the inside of the façade
- wide variety of angular connections to allow greater spatial structure design flexibility
- set of adapted insulators to provide an excellent protection against the construction's heat loss, while their special shape facilitates prefabrication of the façade
- set of gaskets and a 3-zone drainage and ventilation cascade system to ensure proper operation of the façade and to provide protection against the most unfavourable weather conditions
- high capacity mullion-transom connections (3.0 KN) coupled with wide range of glazing to enable the use of various types of glass and installation of large, heavy sets
- wide range of façade-integrated, openable elements: various types of doors and windows, including roof slope windows, façade-integrated windows, tilt and parallel opening windows MB-SR50N OW



TECHNICAL SPECIFICATION	MB-TT50
Mullions depth	65 – 245 mm
Transom depth	64 – 244 mm
Inertia mullions (range Ix)	35.41 – 1639.59 cm <sup>4</sup>
Inertia transoms (range Iz)	28.53 – 1233.76 cm <sup>4</sup>
Glazing width	to 64 mm
Max. weight of façade pane	600 kg

PERFORMANCE	MB-TT50
Air Permeability	class AE 1350Pa, EN 12153; EN 12152
Watertightness	class RE 1800Pa, EN 12155; EN 12154
Windload resistance	2700Pa, EN 12179, EN 13116
Impact resistance	class I5/E5, EN 13049, EN 14019:2006
Resistance to break-in	RC2 & RC3

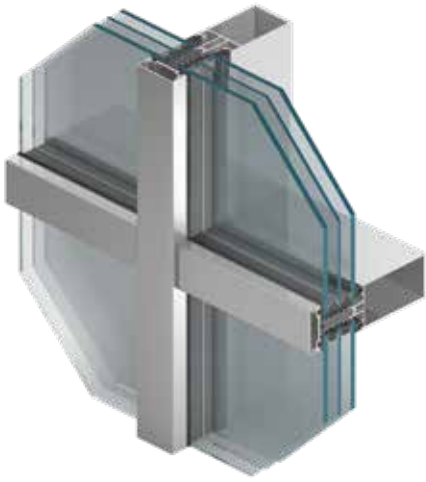

## FAÇADE SYSTEMS

# MB-SR50N HI+

The **MB-SR50N HI+** mullion and transom façade system has been designed to construct lightweight curtain walls of a hanging and filling type as well as roofs, skylights and other spatial constructions.

This system allows façades to be constructed with visible narrow dividing lines while ensuring the durability and strength of the structure. The wide offer of profiles enables the architects and designers to realise even the most enterprising ideas for aluminium and glass structures. To obtain the optimum thermal and acoustic insulation and facilitate mounting in the **MB-SR50N HI+** system façade, the PE insulator was used, as it provides a very good thermal insulation  $U_f$  from  $0.59 \text{ W}/(\text{m}^2\text{K})$  and its shape ensures proper screw driving when glazing the façade. The **MB-SR50N HI+** makes it possible to build curtain walls with slender, visible dividing lines and, at the same time, it provides a solid, hard-wearing structure. The wide range of profiles means that architects and designers have an opportunity to bring even their boldest visions of aluminium and glass structures to life.

$U_f$  from  $0.59 \text{ W}/(\text{m}^2\text{K})$

CWCT certified

**RECOMMENDED  
FOR ENERGY-EFFICIENT  
CONSTRUCTIONS**



**GALERIA KATOWICKA**

Location: Katowice / Poland / Design: SUD Architectes

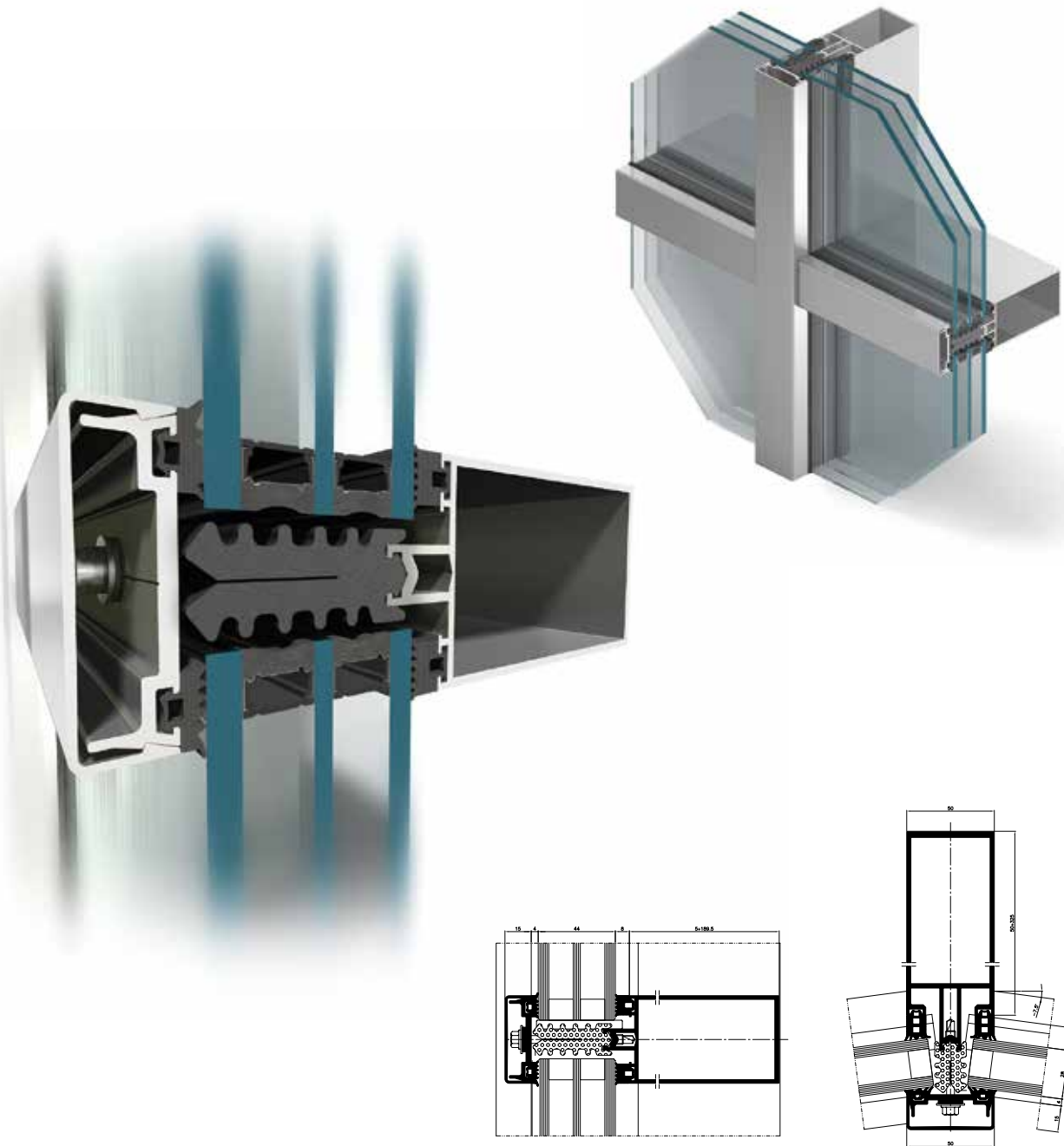

transom – cross-section

mullion – cross-section – 7.5°

## FEATURES AND BENEFITS

- certified highest class A+ by the PHI Darmstadt Institute, MB-SR50N HI+ system can be successfully used in all passive buildings
- angular connections to allow free formation of aluminium developments
- our innovative solution that reduces the deflection of the transom makes it possible to use lites as wide as 4 m
- mullions and transoms with “sharp” edges, to enable fabrication of uniform, truss-appearance, load-bearing curtain walls
- a cutting-edge solution of accessories and connectors making it possible to increase the load-bearing capacity. An infilled, fixed window module in the facade has a capacity of up to 1.100 kg
- aesthetic curtain wall varieties and a number of lining profiles of various shapes providing multiple curtain wall appearances
- wide range of facade-integrated, openable elements: various types of doors and windows, including roof slope windows, facade-integrated windows, tilt and parallel opening windows MB-SR50N OW
- wide range of glazing and available insulators & accessories to achieve a high level of thermal insulation performance
- possibility to bend profiles, and to create arch structures
- compliance with CE marking requirements



## MB-SR50N MB-SR50N HI

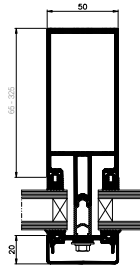

MB-SR50N

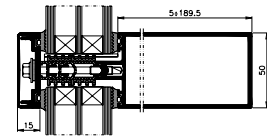

MB-SR50N HI

The MB-SR50N and the version with enhanced thermal insulation, the MB-SR50N HI+, is intended for the design and construction of lightweight curtain and infill walls, roofs, skylights and other spatial structures. In line with current architectural trends, this means that the mullion and transom profiles can be flush on the inside of the façade and makes it possible to obtain a host of different looks for the exterior. The system also constitutes a basis for fire-resistant solutions.

## MB-SR50N EFEKT

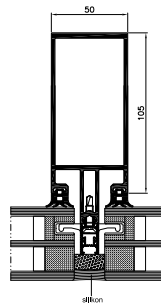

30mm

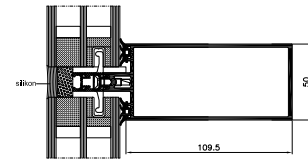

A curtain wall which uses toggles and channels to fix the glazing to provide a uniform appearance of a smooth glass wall divided by a structure of vertical and horizontal lines of a width of 2 cm. It is possible to use within it large and heavy one- or two-chamber glass in-fills, including laminated pane sets and non-transparent panels based on insulated glass.

## MB-SR50N IW

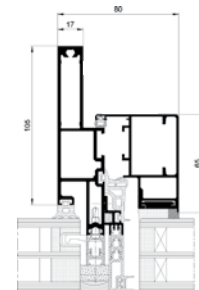
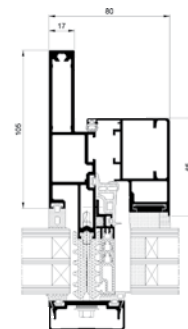
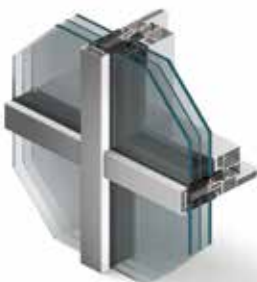

MB-SR50N IW enables the use of inward openable windows integrated with mullion-transom profiles. The area of the façade with tilt-and-turn function does not differ, as seen from the outside, from the neighbouring areas with fixed glazing. This systems comes in 3 varieties: standard, with flat strip and EFEKT.

## MB-SR50N A MB-SR50N A EFEKT

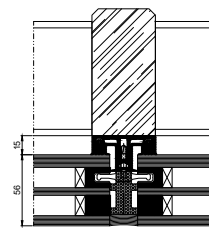
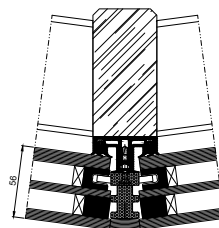
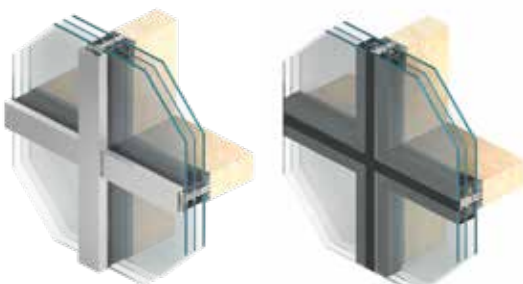

mullion – section view

Add-on system enabling construction of a facade fixed to the timber or steel subframe. With this system it is possible to utilise the desired features of two different structural materials. Glazing with 24 – 64 mm transparent glazing units, 600 kg max. weight of infill. The MB-SR50N A system is also available in "EFFECT" version – without aluminium strips visible from the outside.

## MB-SR50N OW

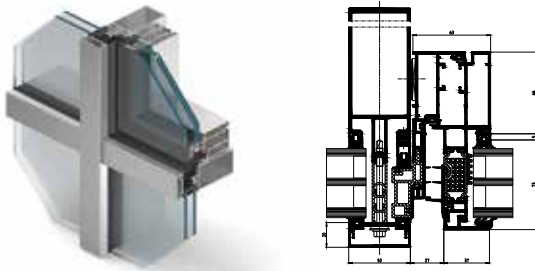

This tilt-and-slide window is a very light structure designed for use in walls and constructed on the basis of aluminium profiles featuring a thermal break. The use of structural bonding technology has made it possible to create a uniform exterior for the elevation, meaning that tilt windows and the fixed elements adjacent to them will look the same. Several variants are available; standard, with a flat strip and an ALUPROF EFEKT-type structure.

## MB-SR50N PL

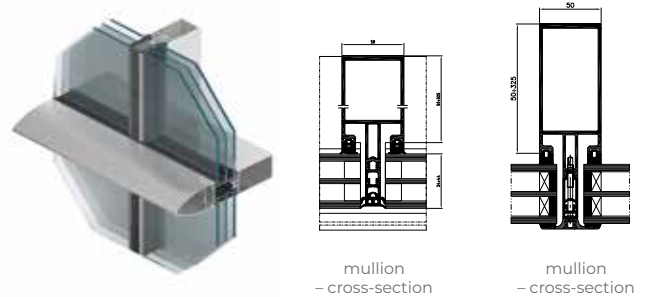

MB-SR50N PL, the so-called "horizontal line", is an aesthetic variant of a mullion-transom façade, in which the external view emphasises horizontal or vertical divisions. This is achieved through the use of appropriate (e.g. elliptical) cover caps, adequately emphasising the single direction of the façade's division.

## MB-SR50N RW

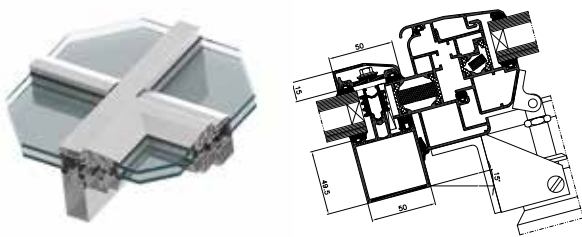

A skylight window is a part of the MB-SR50N system, and is intended for roof mounting at the inclination angle from 5° to 75° in relation to the horizon, and may be used for making the ventilation hatches.

## MB-RW

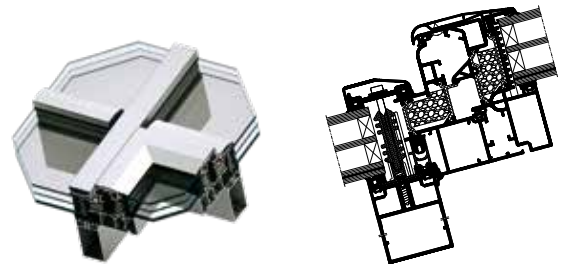

Windows fabricated using the MB-RW system are intended for installation on roofs with mullion-transom systems (MB-SR50N & MB-TT50 group of products) of an inclination angle of 3° to 75° in relation to the horizontal plane. In rafters/purlins axes, roof windows can have dimensions up to 2.5 m and weight up to 200 kg.

TECHNICAL SPECIFICATION	MB-SR50N MB-SR50N HI+	MB-SR50N HI	MB-SR50N EFEKT	MB-SR50N IW	MB-SR50N OW	MB-SR50N RW
Mullions depth	50 – 325 mm			85 – 125 mm	—	—
Transom depth	5 – 189.5 mm			49.5 – 129.5 mm	—	—
Inertia mullions (range wsp. lx)	26.04 – 4123.45 cm <sup>4</sup>			70.43 – 245.70 cm <sup>4</sup>	—	—
Inertia transoms (range wsp. lz)	0.79 – 629.54 cm <sup>4</sup>			23.76 – 205.98 cm <sup>4</sup>	—	—
Glazing width	to 64 mm				28 – 64 mm	24 – 32 mm

PERFORMANCE	MB-SR50N MB-SR50N HI+	MB-SR50N HI	MB-SR50N EFEKT	MB-SR50N IW	MB-SR50N OW	MB-SR50N RW
Air Permeability	AE 1200, EN 12152			class 4, EN 12207		
Watertightness	RE 1200, EN 12154	RE 1500, EN 12154	RE 1200, EN 12154	E 1500, EN 12208	E 1650, EN 12208	E 1200, EN 12208
Wind load resistance	2.4 kN/m <sup>2</sup> , EN 13116			E 2400, EN 12210	class C5, EN 12210	
Impact resistance	I5/E5, EN 14019				—	class 5, EN 13049
Thermal insulation	U <sub>f</sub> from 0.59 W/(m <sup>2</sup> K)	U <sub>f</sub> from 0.85 W/(m <sup>2</sup> K)	U <sub>f</sub> from 1.1 W/(m <sup>2</sup> K)	U <sub>f</sub> from 1.6 W/(m <sup>2</sup> K)	—	—



## FIRE RATED SYSTEM

# MB-SR50N EI

# MB-SR50N EI EFEKT

Aluprof fire protection systems allow to make different building elements responsible for organisation so called fire zones in buildings and ensure suitable conditions for evacuating people.

Mullion-transom curtain walls **MB-SR50N EI** and **MB-SR50N EI EFEKT** are designed for fabrication of lightweight, hung & in-filled fire-resistant curtain walls classified fire-resistant EI 30-EI 60. They allow to create both flat and frangible walls with connections between modules up to  $\pm 7,5^\circ$  aside and tilted curtain walls inclined  $\pm 10^\circ$ . These curtain walls can use MB-78EI-based fire doors. **MBSR50N EI** and **MB-SR50N EI EFEKT** systems can be used as a basis for fire-resistant glazed roofs of an inclination angle of  $0^\circ$  to  $80^\circ$  classified fire-resistant REI 30 / RE 45.

fire resistance up to EI60

certified by Exova Certifire



**GREEN HORIZON**

Location: Łódź / Poland / Design: Medusa Group

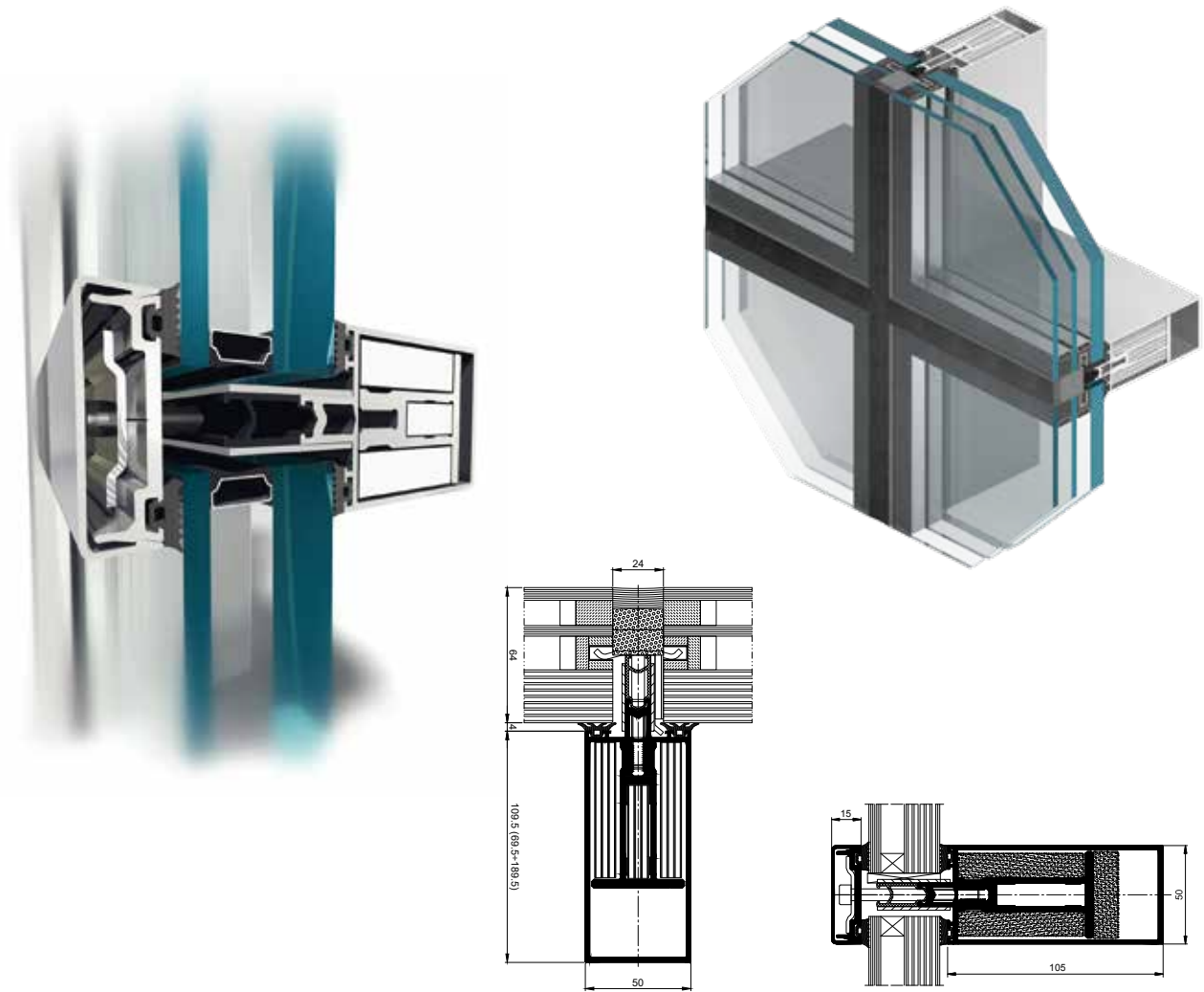

mullion – cross-section EI 45, EI 60

transom – cross-section EI 15, EI 30

## FEATURES AND BENEFITS

- the same appearance for fire and non-fire rated elements of curtain wall facade
- various design and aesthetics options for capping
- system flexibility allows faceted joints up to  $\pm 7.5^\circ$  per side, and inclined facades up to  $\pm 10^\circ$  as well as slope & roof glazing between  $0^\circ$  and  $80^\circ$
- full compatibility with MB-78EI system allows fire rated door to be fitted into a curtain wall



TECHNICAL SPECIFICATION	MB-SR50N EI	MB-SR50N EI EFEKT
Frame / mullions width	85 – 225 mm	85 – 225 mm
Leaf / transom width	69.5 – 189.5 mm	69.5 – 189.5 mm
Inertia mullions (range Ix)	81.34 – 1222.14 cm <sup>4</sup>	81.34 – 1222.14 cm <sup>4</sup>
Inertia transoms (range Iz)	49.54 – 629.54 cm <sup>4</sup>	49.54 – 629.54 cm <sup>4</sup>
Glazing width	16 – 64 mm	36 – 64 mm

### SIZE AND WEIGHT LIMITATIONS

Max. size of door leaf / curtain wall element (H×W)	H to 3000 mm / 1200 mm; W to 1500 mm / 1800 mm
Max. weight of door leaf / curtain wall	300 kg

PERFORMANCE	MB-SR50N EI	MB-SR50N EI EFEKT
Air Permeability	1050 Pa class AE, EN 12152	class AE1200 Pa; EN 12153
Watertightness	class RE1200, EN 12154	class RE1200; EN 12155
Fire resistance	EI30, EI60, EN-13501-2, roof lights: RE130, RE45, EN 13501-1	
Thermal insulation	U <sub>f</sub> from 1.78 W/(m <sup>2</sup> K)	

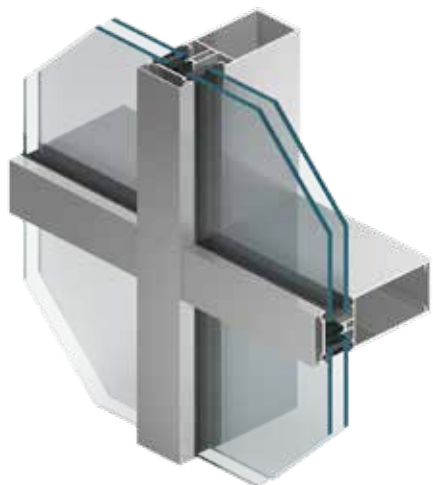

## FAÇADE SYSTEMS

# MB-SR60N MB-SR60N HI+ MB-SR60N EFEKT

This façade system has been designed for producing lightweight, flat, suspended or infilled curtain walls and other spatial structures. The 60 mm-wide mullions and transoms allow for the construction of aesthetically appealing façades with visible narrow dividing lines to ensure durability and strength of the entire structure. Mullions and transoms can be aligned on the inside and help obtain different versions of the external appearance. The **MB-SR60N** system offers excellent performance and it provides freedom of shaping the space as well as the variety of openable elements that can be installed in the façade.

Particularly noteworthy is the version with improved thermal insulation: **MB-SR60N HI+** that uses special insulators.

load of the transom: up to 1100 kg



PPNT

Location: Gdynia / Design: AEC Krymow & Partnerzy



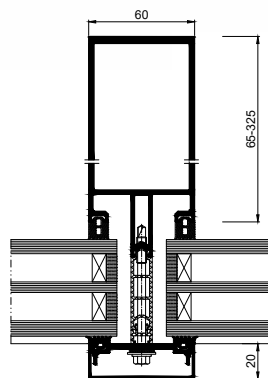
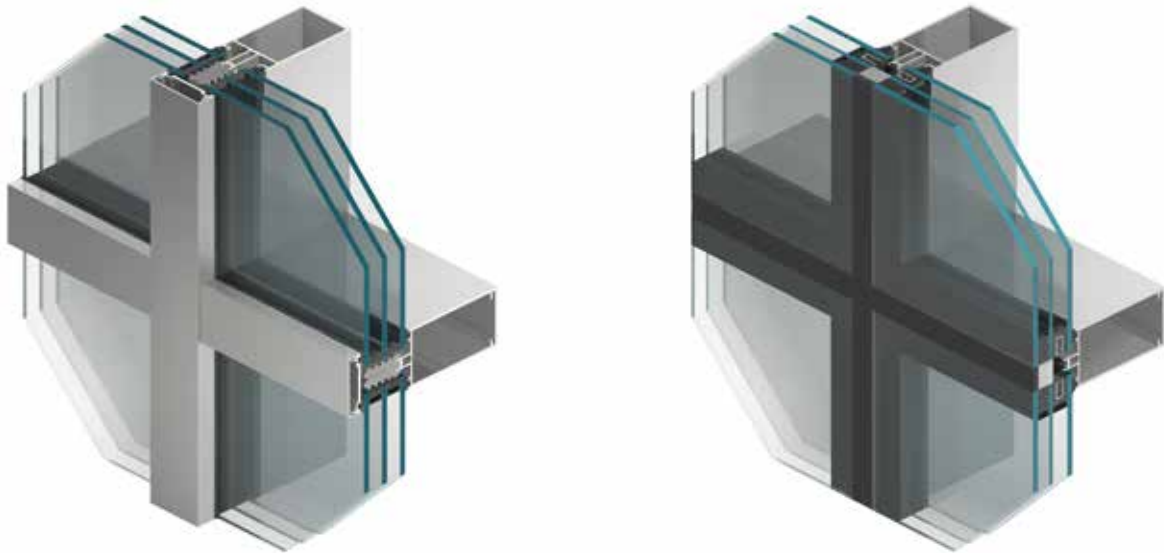

mullion – cross-section

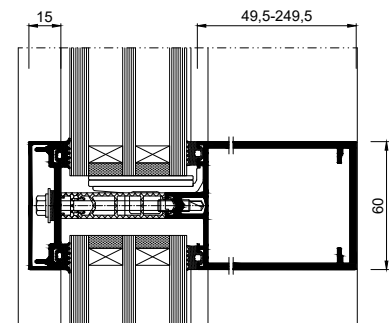

transom – cross-section

## FEATURES AND BENEFITS

- depth of profiles: mullions: 65 – 325 mm, transoms: 49.5 – 249.5 mm
- the system can use infills as thick as 24 – 72 mm
- MB-SR60N EFEKT version is also available, it is similar in appearance to a structural wall – from the outside, it has a uniform, smooth glass wall divided by 24 mm wide vertical and horizontal lines
- our innovative solution that reduces the deflection of the transom makes it possible to use lites as wide as 4 m
- a cutting-edge solution of accessories and connectors making it possible to increase the load-bearing capacity. An infilled, fixed window module in the façade has a capacity of up to one thousand, one hundred kilograms.
- modern accessories and fasteners allow for improved load-bearing capacity – the infill of the fixed façade module can weigh up to 1,100 kg
- the version with improved thermal insulation, MB-SR60N HI+, features a profiled LDPE insulator

TECHNICAL SPECIFICATION	MB-SR60N / MB-SR60N HI+ / MB-SR60N EFEKT
Mullions depth	65 – 325 mm
Transom depth	49.5 – 249.5 mm
Inertia mullions (range Ix)	59.66 – 5856.30 cm <sup>4</sup>
Inertia transoms (range Iz)	32.07 – 1269.13 cm <sup>4</sup>
Glazing width	4 – 72 mm

PERFORMANCE	MB-SR60N / MB-SR60N HI+	MB-SR60N EFEKT
Air Permeability	class AE 1350, EN 12152	AE 1200, EN 12152
Watertightness	class RE 1500, EN 12154	RE 1200, EN 12154
Windload resistance	2.4 kN/m <sup>2</sup> , EN 13116	
Acoustic Insulation	R <sub>w</sub> =45 dB (depending on the type of infill used)	
Impact resistance	I5/E5, EN 14019	

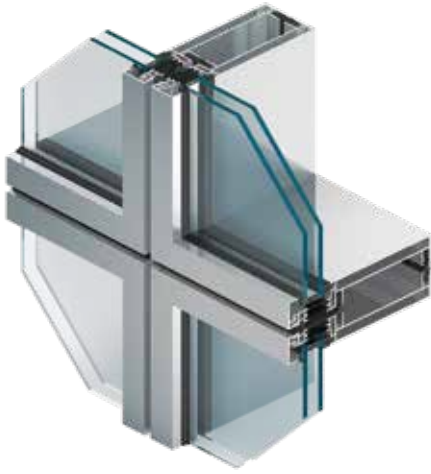

## FAÇADE SYSTEMS

# MB-SE75

# MB-SE75 HI

The **MB-SE75** unitised curtain wall offers the advantage of unitised assembly giving the construction team a distinctive exceptional set of advantages. These include factory fabrication that allows for additional quality control, fast on site installation without the need for expensive and time consuming scaffolding and both outer and inner modern look. It enables to meet fast paced construction schedules as it requires only limited access to assembly therefore building can be refurbished with residents still being in it.

a quick installation without an external scaffolding usage



**MASARYKA UNIVERISTY CAMPUS**

Location: Brno / Czech Republic / Design: A-PLUS

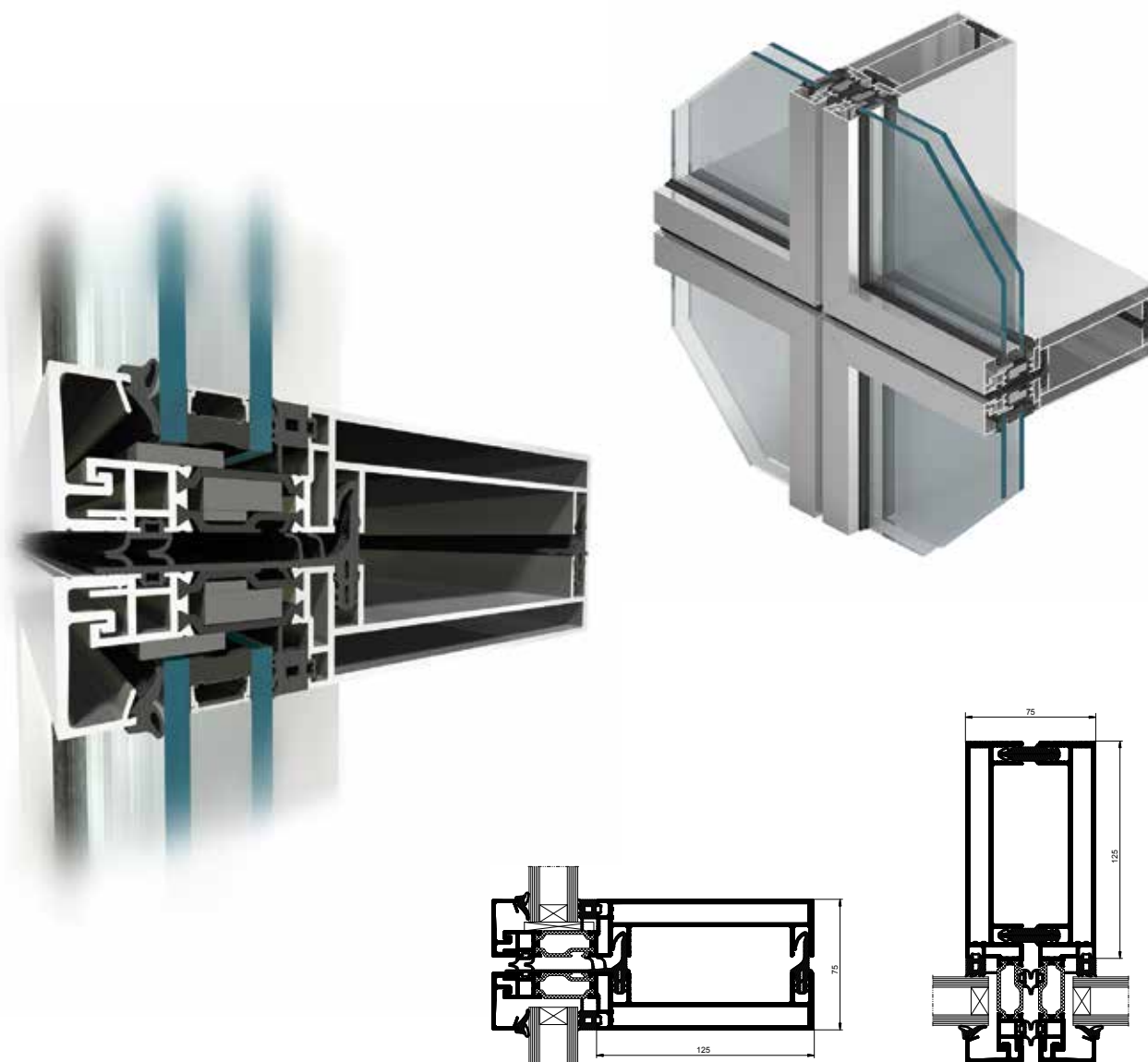

transom – cross-section

mullion – cross-section

## FEATURES AND BENEFITS

- great variety of façade-integrated opening elements – windows and doors with enhanced thermal insulation, windows with concealed sash MB-70US, MB-70US HI or version MB-70SG, as well as "frameless" constructions reclining on the outside, based on the structural system MB-SG50

TECHNICAL SPECIFICATION	MB-SE75 / MB-SE75 HI
Mullions depth	85 – 145 mm
Transom depth	84.5 – 144.5 mm
Inertia mullions (range Ix)	101.2 – 366.1 cm <sup>4</sup>
Inertia transoms (range Iz)	143.1 – 523.7 cm <sup>4</sup>
Glazing width	24 – 42 mm

PERFORMANCE	MB-SE75 / MB-SE75 HI
Air Permeability	class AE1200 EN 12153; EN 12152
Watertightness	class RE1200 EN 12155; EN 12154
Impact resistance	class I5/E5 EN 14019
Windload resistance	2400 Pa EN 12179:2002U; EN 13116:2002U
Thermal insulation	U <sub>f</sub> from 1.5 W/(m <sup>2</sup> K)
Acoustic insulation	R <sub>w</sub> Measured individually



## RAIN SCREEN FACADE SYSTEMS **EXTRABOND**

**EXTRABOND** rain screen facade is used to make internal and external cladding in new and/or modernized buildings to give them a modern and aesthetic appearance. **EXTRABOND** are highly resistant to weather conditions, UV, corrosion and abrasion. Additionally, the system has properties that reduce noise and allows to limit heat loss. Extrabond panels are available in wide range of colors. Among the panels available: **EXTRABOND** which are characterized by high durability and resistance to weather conditions, and EXTRABOND A2 & EXTRABOND FR with an even better reaction-to-fire performance (EXTRABOND A2 - reaction-to-fire A2-s1, d0i, EXTRABOND FR – reaction-to-fire B-s1, d0). These are additionally classified as non-fire spreading (NRO).

Depending on to the dimensions of the panels or on the type of the cladding, EXTRABOND ventilated facades family can be divided into three types: EXTRABOND Horizontal (EBH), EXTRABOND Vertical (EBV), EXTRABOND T (EBT). **EXTRABOND** – a perfect solution for those who look for a system that combines technical parameters with aesthetic requirements.

highly aesthetic facades



**GEMINI PARK**

Location: Bielsko-Biała / Poland / Design: Wojciech Kurzak Vide Studio

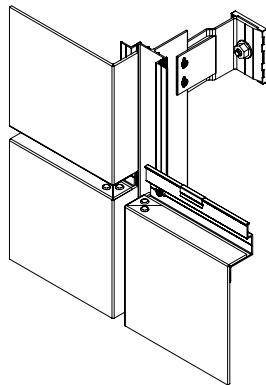
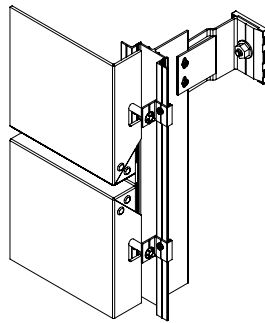
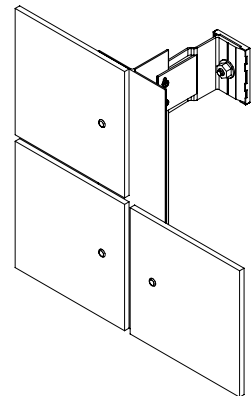
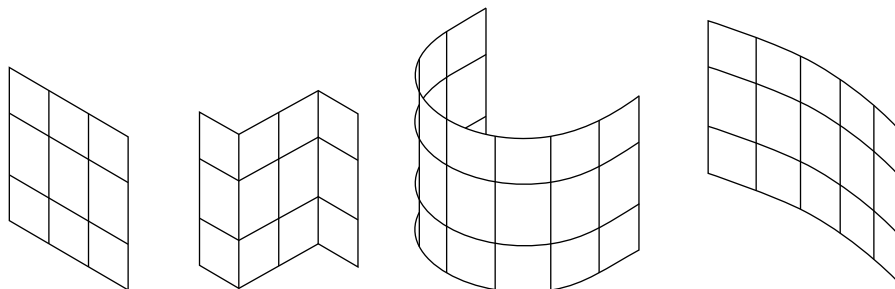
**Extrabond Horizontal EBH****Extrabond Vertical EBV****Extrabond T EBT****OPTIONS AVAILABLE****FEATURES AND BENEFITS**

- composite panel with a thickness of 4 mm, sheet metal panel of a thickness of 0.5 mm (alloy AW-3005)
- high resistance to weather conditions, UV, corrosion, abrasion and graffiti
- high durability thanks to the robust, light and rigid materials – 20 year warranty
- easy and quick installation, ease of shaping
- rich colors and highly esthetical panels with a totally smooth surface
- fire resistance, sound-proofing and high impact resistance
- low heat and noise transfer coefficient
- this product is environmentally friendly (made from non-hazardous materials, 100% recyclable)

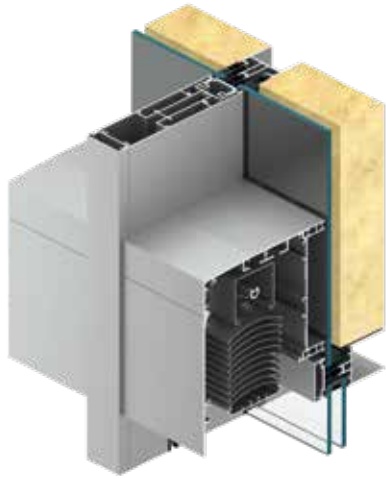

## MULLION AND TRANSOM CURTAIN WALL SYSTEM INTEGRATED WITH SKYFLOW VENETIAN BLINDS

# MB-SR50N ZS

The **MB-SR50N ZS** system is an innovative solution combining the **SkyFlow** venetian blind system with Aluprof's mullion-transom curtain walling system **MB-SR50N**. It has been created primarily for the construction of buildings where complete harmony between the technical and aesthetic aspects plays a particular role. With this in mind, we designed clamping strips, making it possible to fit the façade infills and concealing strips, which also act as the guides for the external blinds. This means that the decision to use this kind of blind can be taken later on in the process, when the façade has already been installed. The entire mechanism is discreetly concealed in an aesthetic, extruded aluminium headbox. The **MB-SR50N ZS** is available with aluminium or cord guides. The maximum dimensions are 4500×4000 mm.

aesthetics and protection from the sun



Full system integration

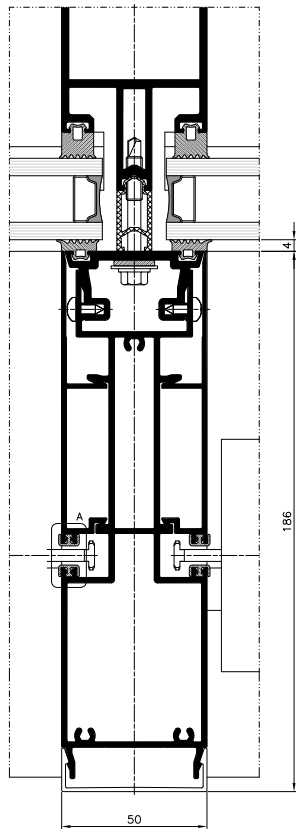

mullion – cross-section

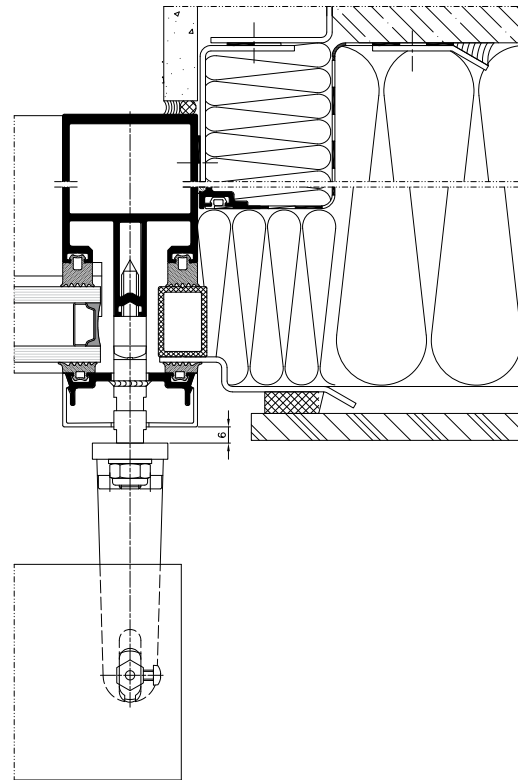

mullion – cross-section

## FUNCTIONS AND AESTHETICS

- two types of pin are available. One is hard-wearing aluminium. The other is PVC, which minimises wind noise
- two types of slat are available. The C-shaped slats curve inwards on both sides, guaranteeing their rigidity and wind-resistance. The Z-shaped slats provide greater airtightness and, by the same token, a deeper darkness
- the guides, which are the only one of their kind on the market, are fitted with special sound dampers that eliminate the noise of the slats clattering against them
- the ladders and tapes are made using polyester fabric. They are thermally treated, making them resistant to weather, stretching, wear and the action of UV radiation and mould
- as the blind closes, the ladders form 8-shaped folds, preventing them from getting tangled up between the slats and keeping the action smooth
- the mullions of the façade are fitted with clamping strips, making it possible to fit the façade infills and cover caps, which also act as the guides for the external blinds



## EXTERIOR VENETIAN BLINDS **SkyFlow**

Fitting façades with external venetian blinds is a highly practical way of blocking out the sun and effectively protecting interiors from overheating while providing comfortable optical conditions. Regulatable slats are typical feature of these products, giving users the freedom to select the angle and degree of shading which works best for them. At the same time, the aesthetic profile of the slats and the aluminium structural elements in the form of the headbox and guides, give façades a contemporary, original look. Well-designed, well-made structures of this kind also make it possible to create large-scale constructions, so they are very often used for extensive glazing. As a result, external venetian blinds have been employed to excellent effect in public buildings and residential developments alike. The ALUPROF range offers a system in three variants; front-mounted, flush-mounted and self-supporting.

**guides fitted with customised sound**



**Effective sun control**



## SkyFlow SZF/A

This front-mounted venetian blind is designed to be used on the elevations or in the window recesses of existing buildings. The standard headbox is made of 1.2-millimetre-thick aluminium sheeting and the casing is available in four variants. If special requirements for durability need to be met, there is also a version made of 2-millimetre-thick sheeting. The system comes with either aluminium guide channels or wire guides. Telescopic anchors are available for the aluminium guide channels. The Skyflow SZF/A has been designed to allow the venetian blind to be split into sections by using a dual guide. ALUPROF is the only manufacturer on the market offering a regulated, internal connector for corner installations, making it possible to achieve a highly aesthetic final effect. The max. size of a single venetian blind for aluminium guides is 4500×4000 mm (max. surface area 18m<sup>2</sup>) and, for linear guides, 4000×3000 mm (max. surface area 12 m<sup>2</sup>).



## SkyFlow SZF/S

A self-supporting venetian blind, the SZF/S was designed primarily for use on the façades of buildings featuring extensive glazing. The wellthought-out structure means that the guides are a load-bearing element, transferring the entire weight of the blinds to the mullions of the façade. At the same time, no additional mounting is need for the extruded aluminium box, which, with its aesthetic finishing, also serves as decoration. It is available in two shapes, oval and square, and the guides are adapted accordingly. The Skyflow SZF/S can be installed modularly, with one headbox of up to 6000 mm. The max. dimensions are 4500×4000 mm (max. surface area 18 m<sup>2</sup>).



## SkyFlow SZF/P

This under plaster venetian blind is intended for newly constructed buildings or existing buildings where essential alterations have been carried out on the lintels. It is therefore worth planning its use at the design stage. The extruded aluminium headbox has a special medium for plaster, making it possible to use all kinds of finishing materials. The SZF/P guides are designed to be built in. The oval and square guides from the SZF/S self-supporting version can also be used, as can those from the SZF/A front-mounted variant. The max. dimensions are 4500×4000 mm (max. surface area 18 m<sup>2</sup>).



## SkyFlow SZF/BX

The venetian blind in the BX under plaster version was designed mainly for easy and quick installation in newly built buildings. The cover box is a ready-made element and is made of bent aluminium sheet. It can be fitted with a plaster foundation on both sides, allowing any plasterwork to be carried out. The system has dedicated guide channels to facilitate on plaster mounting in two sizes. Max. dimensions are 4500×4000 mm (max. surface 18 m<sup>2</sup>).



## FUNCTIONS AND AESTHETICS

- two types of pin are available. One is hard-wearing steel. The other is PVC, which minimises wind noise
- venetian blind slats made of aluminium sheet available in two shapes: C and Z. Stiffness and wind resistance is guaranteed in the case of blinds slats profiled in the shape of the letter C and their double-sided folding inwards. In addition, their rotation range is from 0° to 180°. The slats in the shape of the letter Z are designed to provide complete shading and are additionally equipped with a special soundproofing seal. Their rotation range is from 0° to 90°
- the guide channels, the only solution of this type available on the market, are equipped with special seals eliminating the noise that can arise when the slat hits the guide channel
- the textile elements of the venetian blind are made of high quality polyester and they are thermally fixed, which guarantees high resistance to weathering, stretching, abrasion, as well as UV rays and the appearance of mould. The ladder braid is arranged in the shape of the number 8, which ensures smooth rolling. In addition, the Z90 slats are equipped with a special mechanism that provides a lower height of the package. Textiles are available in grey and black
- two variants of the endslat: complete and open
- the under plaster version can be fitted with housing for the guides.

## EXTERNAL ROLLER BLINDS **SkyRoll (screens)**



External roller blinds (screens) are a highly functional solution which is frequently used for public and residential buildings alike. The main advantage of these products is the protection they provide interiors against exposure to the sun as a result of their specialist, technical fabrics. They also provide privacy by stopping people outside from seeing in, while giving users an excellent view out. In addition, they offer optical comfort by acting as an effective barrier to exterior light and minimising the screen glare it can trigger. With the right choice of fabric, external roller blinds become a stylish accessory, adding a unique decorative flourish to a building. It is worth noting that, when properly chosen, they can also function as efficient insect screens, keeping interiors 'bug-free'. The ALUPROF range offers three systems, the **SkyRoll ZIP**, the **SkyRoll CLASSIC** and the **SkyRoll ECO**.

three structural versions



Elegant protection from intensive exposure to the sun

## SkyRoll ZIP



The ALUPROF SkyRoll ZIP is a state-of-the-art product designed to shade interiors with extensive glazing. One thing that makes it exceptionally innovative can be found on the edges of the fabric, where the technology used has been borrowed from the mechanism of zip fasteners. This means that the specially designed, two-part guides are directly integrated into the fabric, guaranteeing maximum airtightness and protection against the ingress of direct light and insects. In addition, the solution not only ensures the proper tautness of the fabric, but also that it is stably fixed in the guides, which provides protection in gusting winds. The SkyRoll ZIP is available in three variants; flush-mounted, top-mounted and front-mounted. The maximum dimensions are 5000×5000 mm (max. surface area 16 m<sup>2</sup>).

## SkyRoll CLASSIC



The ALUPROF SkyRoll CLASSIC is the most popular of our roller screen systems intended for use in public and contemporary residential buildings alike. It is a superb way of reducing solar radiation without sacrificing daylight and provides optimum protection from overheating indoors. With this system, the fabric is not directly integrated with the guides. The SkyRoll CLASSIC is available in three variants; flush-mounted, top-mounted and front-mounted. The maximum dimensions are 5000×5000 mm (max. surface area 16 m<sup>2</sup>).

## SkyRoll ECO



The ALUPROF SkyRoll ECO is a low-budget solution created for less demanding developers. It is ideal for buildings in need of permanent protection from the sun and works just as well for balconies, gazebos and pergolas. The screen is springloaded and operated manually. It features an intuitive opening and closing mechanism, which makes it easy and effortless to use. The SkyRoll ECO is available in two variants; top-mounted and front-mounted. The maximum dimensions are 2000×2500 mm.

## FUNCTIONS AND AESTHETICS

- available in three versions, the ZIP the Classic and the ECO, adapted to the developer's requirements
- the first external roller blind on the market to feature a blocking mount in the closed position, making it easier to install, uninstall and access for servicing
- the well-designed and well-made structure of the ZIP version means that, when the blind is closing, the fabric winds onto not only the roller tube, but also the adapter making the process more effective
- the use of the zip mechanism in the SkyRoll ZIP system means that the fabric can be directly integrated with the guides, ensuring wind resistance and guaranteeing maximum airtightness and protection against the ingress of direct light and insects
- the use of the ALU-CLICK mechanism in the SkyRoll ECO system ensures that it is simple and comfortable to operate manually
- three headbox variants; front-mounted, flush-mounted and top-mounted
- the top-mounted headbox is insulated in order to minimise the occurrence of thermal bridges. It is also the only solution on the market to feature insulated sides, as well

## PERGOLA SYSTEM

# MB-OpenSky 120



**MB-OpenSky 120** is a unique product that perfectly fits in with the trends of modern construction and is characterised by its high durability and high quality of details. The use of an innovative method of fitting profiles has ensured the stability of the entire system, as well as aesthetically pleasing connections with invisible gaps. The roofing of the **MB-OpenSky 120** pergola is a module made up of movable slats (two shapes available), equipped with a mechanism enabling smooth change of its inclination angle from 0 to 135° on the axis. The transmission mechanism, equipped with an automatic adjustment system, allows rapid installation on-site and easy and problem-free adjustment of the individual slats. The clever design of the **MB-OpenSky 120** pergola makes it durable and resistant to weather conditions. The product has been equipped with a gabled drainage system, allowing rainwater to be effectively drained from the roof inside the entire surface of the column. There is a free-standing version and the ingenious design of the product predicts to use side screens such as sliding glass panels and/or screens.

the maximum dimensions are 6 m long × 4 m width × 3 m height



Perfect in every way

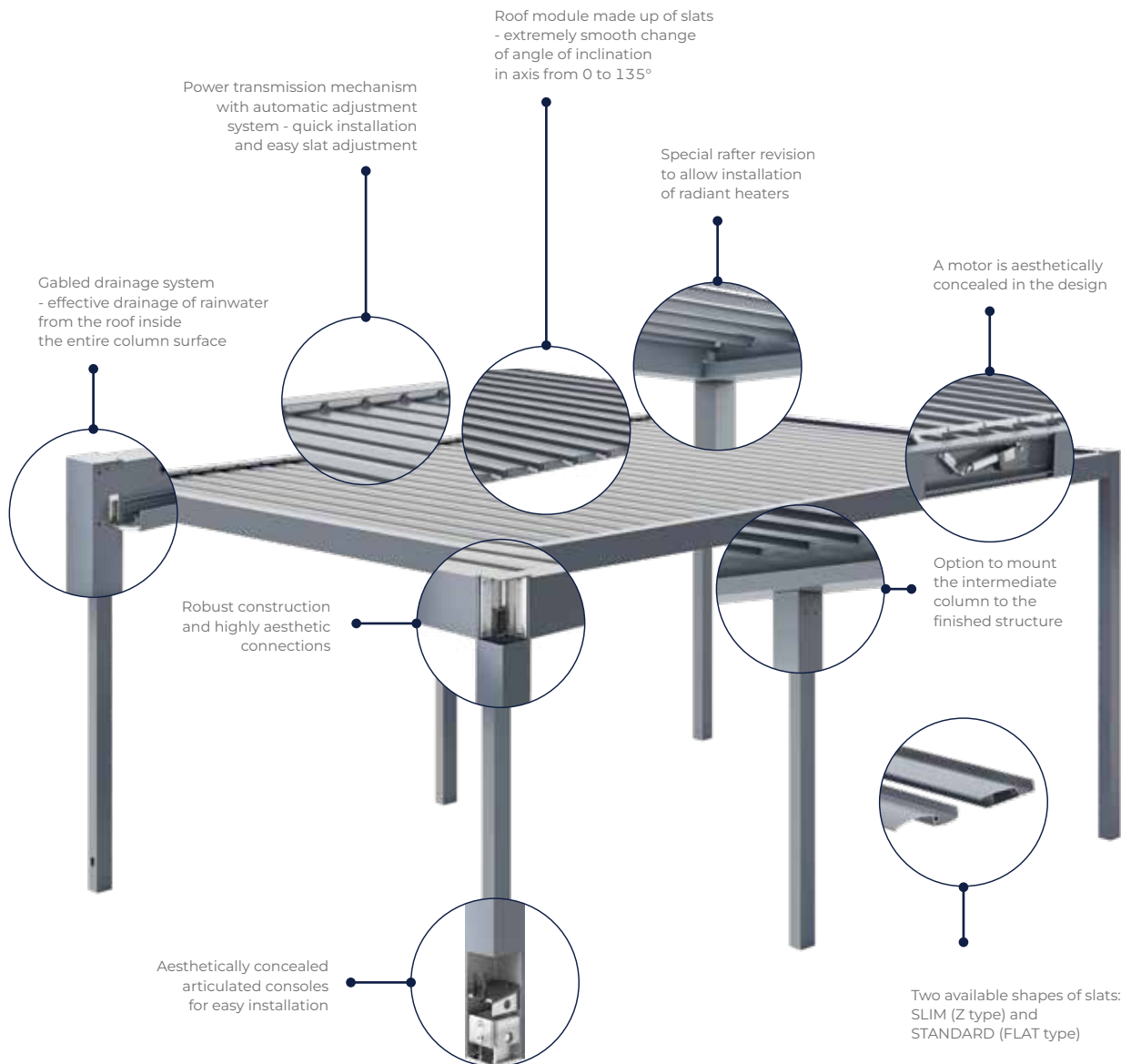

## EASE OF USE

The MB-OPENSKY 120 pergola is equipped with an electric drive that allows the use of SMART technology control devices from various manufacturers, including Somfy. Pergola can be operated using a remote control, a switch, a mobile phone app or the desired scenario programmed into a smart home control system.

The pergola can also be fitted with further accessories.

## PRACTICAL VALUES

The clever design of the MB-OpenSky 120 pergola allows for any arrangement. It is possible to incorporate side screens such as screens, sliding glass panels or both solutions at the same time. In this way, we can create a unique atmosphere in a natural setting regardless of the prevailing weather conditions. What's more, the product also has the option of LED lighting.

The lighting has been designed to work non-invasively with the roof slats. The available solution provides for its installation in the form of an LED strip both in the roof slat (linear for SLIM slats, punctual for STANDARD slats) and along the outline of the structure. In addition, a special revision in the rafter makes it possible to install radiant heaters.

## COLOUR CHARTS

The extruded aluminium structure can be coated with any colour from the RAL palette. It can also be coordinated with the joinery of a building's window and/or façade. Up to 12 colours are available in the standard palette. The powder coating technology ensures the durability and strength of the coating for many years of use.

## PERGOLA SYSTEM

# MB-OpenSky 140



Pergola is a modern and extremely functional solution, used as roofing for terraces or separate garden areas, which, depending on the needs and creativity of the user can find a number of applications. **MB-OpenSky 140** structure is made of extruded aluminium, which guarantees its durability for years. An innovative method of spacing the profiles with custom-designed pins makes it possible both to ensure the stability of the entire system and to create an aesthetic connection with no visible gaps. The canopy is formed by a module composed of movable slats and fitted with a mechanism for changing their angle on an axis from 0 to 135°. The slats feature tailor-made seals for protection against rainwater and there is a drainage system located in the posts. This ensures that water is efficiently fed through gutters and downpipes to the storm drain. pergola is resistant to snow load and powerful wind gusts. There is a free-standing version and a wall-mounted version, which comes complete with a custom-designed bracket, making it possible to insulate the wall. We also offer two-bay solutions, making it possible to extend the useable area.

the maximum dimensions of one section are 7 m long × 5 m width × 3 m height



Thoughtful technology and aesthetic details

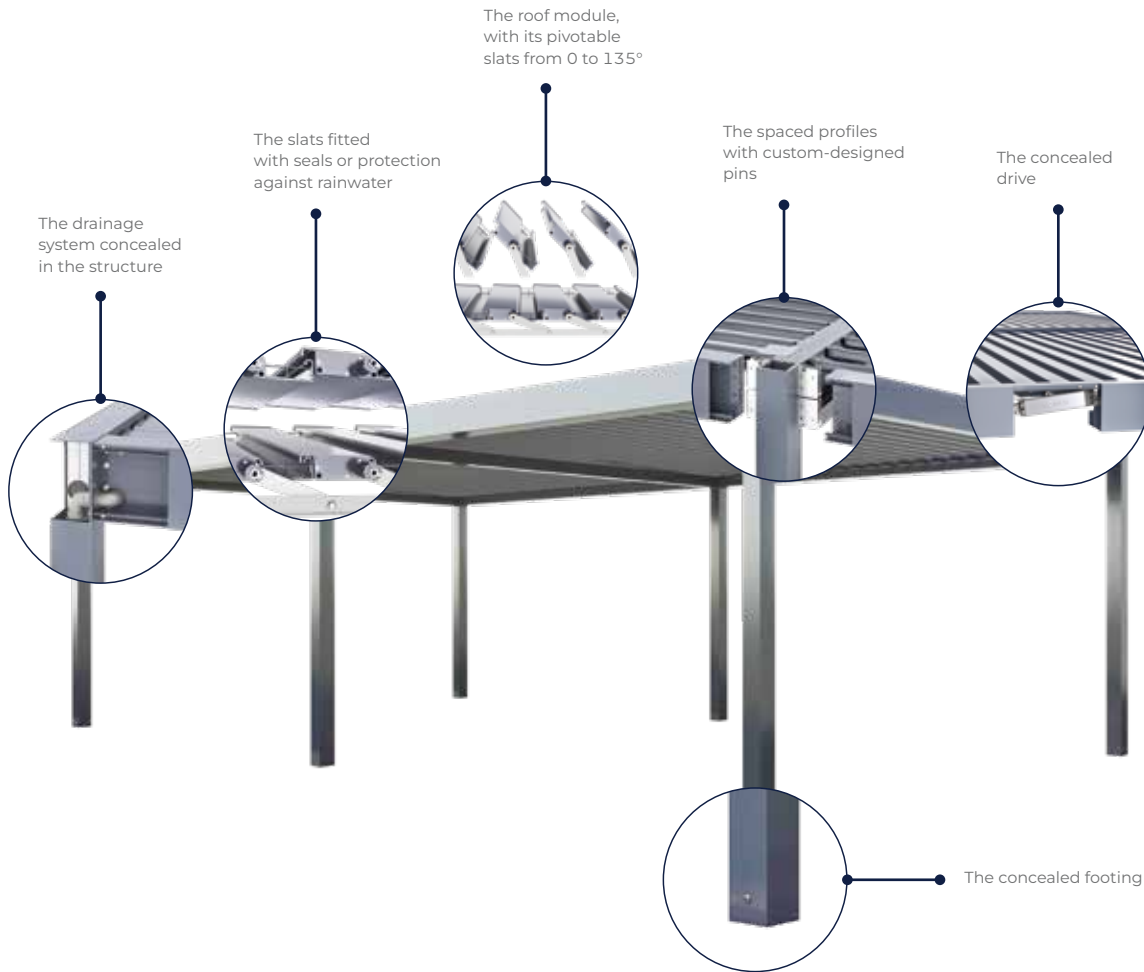

## EASE OF USE

The MB-OpenSky 140 pergola is equipped with a fully electric roof-control mechanism that is completely concealed in the structure. The angle of the slats can be smoothly adjusted to anywhere between 0 and 135°, which provides full control not only of how much sunlight is allowed in but also of the natural ventilation. The mechanism can be operated using a remote control, a switch, a mobile phone app or the desired scenario programmed into a smart home control system. The pergola can also be fitted with further accessories, including a wind sensor, a rain sensor and/or a sun sensor, all of which significantly enhance user comfort.

## PRACTICAL VALUES

The ingenious design of the ALUPROF MB-OpenSky 140 means that side blinds or sliding glass panels can be fitted. This opens up the possibility of creating a unique atmosphere, surrounded by nature, no matter how the weather is! The pergola can also be equipped with LED lighting tailored to work without affecting the roof slats and heating unit. The solution provides for it to be installed in the form of a LED strip on the roof slats and a spotlight, together with additional lighting, around the upper edge.

## COLOUR CHARTS

The extruded aluminium structure can be coated with any colour from the RAL palette. It can also be coordinated with the joinery of a building's window and/or façade. The powder coating technology ensures that the coating is tough and will endure for years.

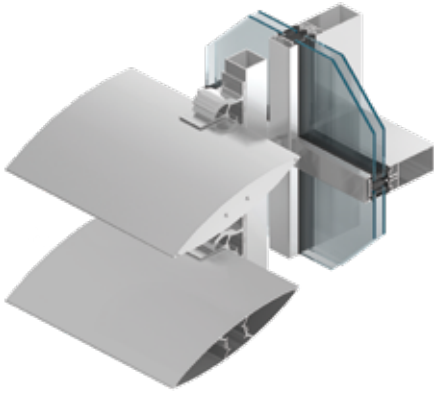

## BRIE SOLEIL SYSTEM **MB-SUNPROF**

Saving energy by reducing exposure to direct solar radiation while allowing for natural day lighting is one of a major focus of today's environmentally aware engineers, architects and specifiers. **MB-SUNPROF** brie soleils have been designed to meet these requirements. The system comprises aluminum blades, which are available in variety of sizes and integrate the Aluprof's curtain wall systems range, providing an impressive visual effect that helps unite the building envelope. It includes roller shutter profiles available in various sizes and accessories to enable façade-integrated installation at the right angle.

a perfect light and shading balance



**SUWALKI TECHNOLOGY INCUBATOR**

Location: Suwałki / Poland / Design: ARH+ Architect Andrzej Rydzewski



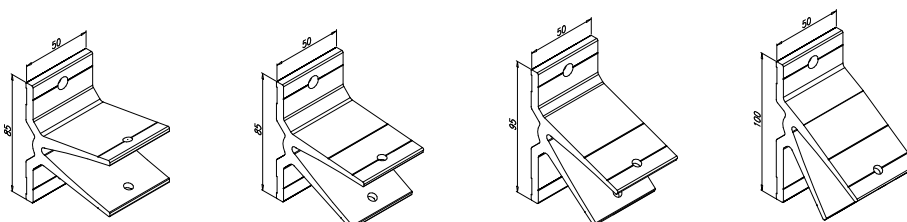
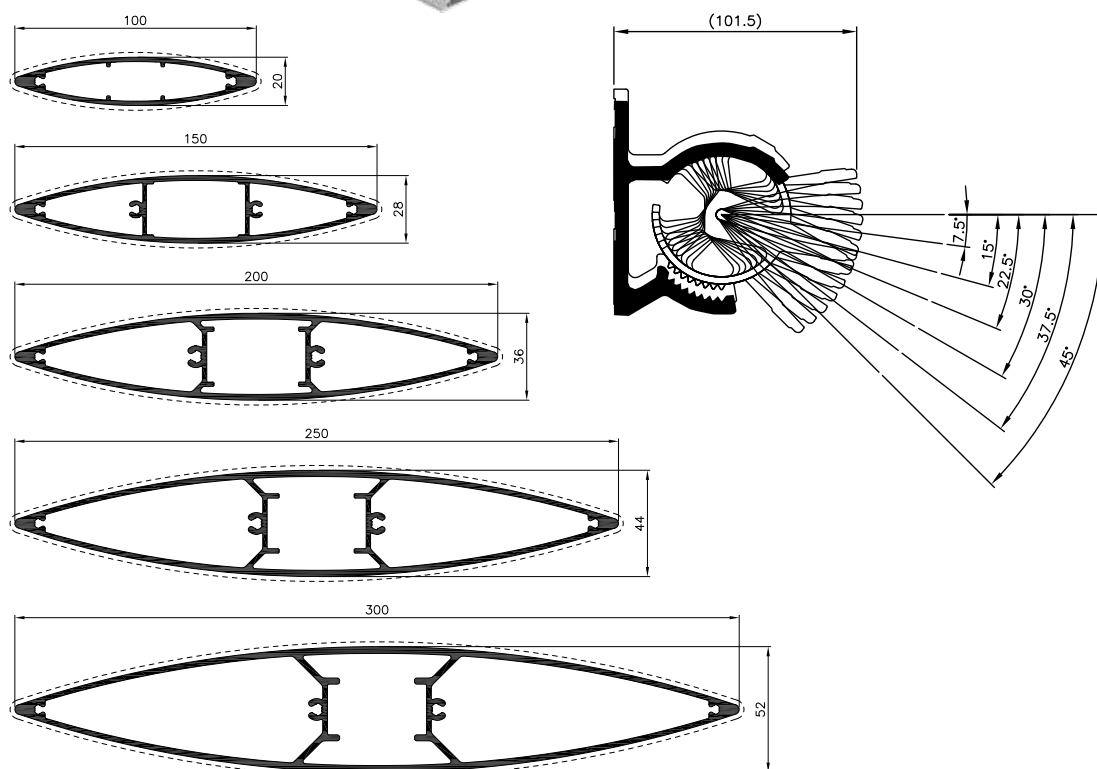
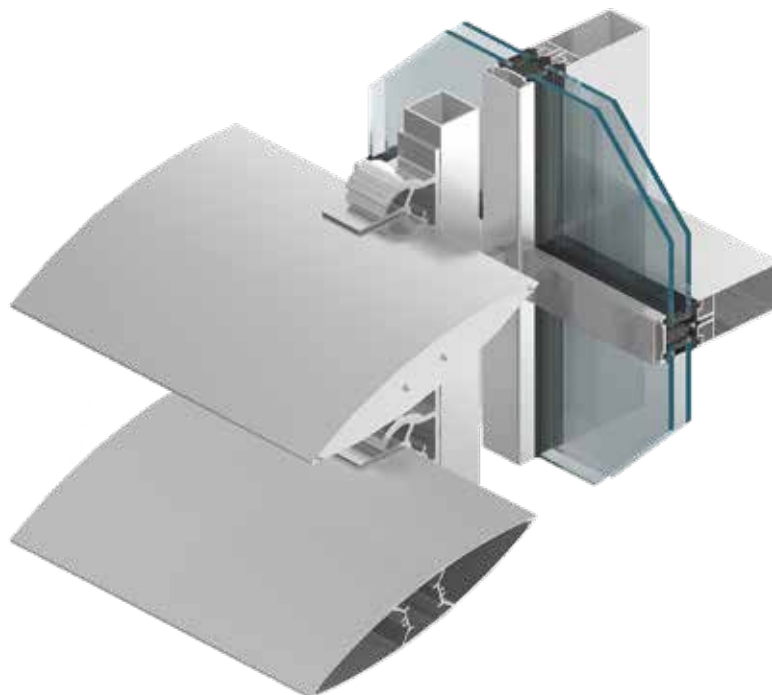

## FEATURES AND BENEFITS

- brings together solar glare control with the appropriate amount of natural light coming into the building's internal environment
- range of outriggers (brackets) to choose from
- selection of aluminum blade profiles of width from 100 to 300 mm to serve variety of projects' requirements
- up to 45° incident angle
- quick and easy to install to the curtain wall, load bearing wall or window frame



## SHUTTER SYSTEM **MB-SUNSHADES**

**MB-SUNSHADES** provide an excellent solar shading and give the external wall its characteristic appearance. The solution consists of a frame with diagonally arranged blades or panels. Made of aluminium, the components are highly resistant to weather conditions and do not require any renovation work during years, which distinguishes them from structures built with PVC or timber. Frame profiles are slim and light, but of appropriate stiffness, which allows to fabricate both curtains for windows and patio doors.

Aluprof's **MB-SUNSHADES** are an option for those who look for practical yet aesthetic solutions. The shutters can be colour-matched with the external wall or with the windows or used simply as a remarkable accent on the wall. Given the ample possibilities offered by the technology of decorative and protective coatings made on aluminium, the **MB-SUNSHADES** are perfect for use in various types of construction: traditional buildings will successfully call for structures with timber-like texture, where as in modern homes, a colour combination of a structure with muted colours, identical to those of the windows, especially impressive when windows and doors are made of aluminium.

making your home exceptional



Shutters by ALUPROF – protecting and embellishing your home

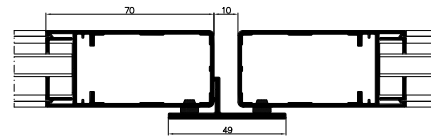

casement, horizontal view

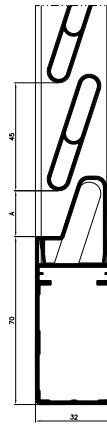

louvres, vertical view

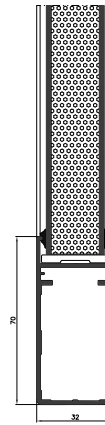

paneled shutter, vertical view

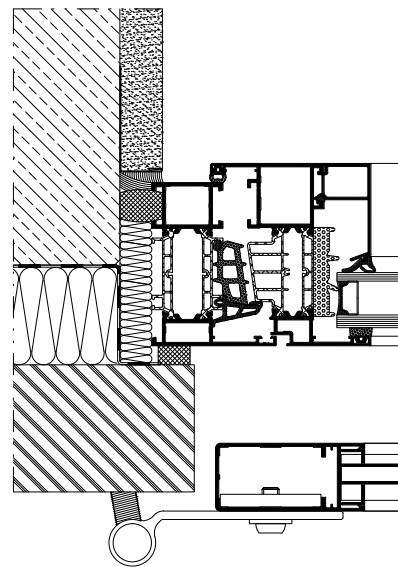

how to install

## FEATURES AND BENEFITS

- MB-SUNSHADES – a unique visual effect and an effective sun protection
- wide range of colors – all RAL and ADEC wood-like colours available
- lightweight and resistant structure, with the infill of your choice: aluminium slats or aluminium panel
- maximum dimensions of the shutters are 1.2 m × 2.5 m, which allows to use them of not only in standard window openings but also in door's
- the hinges available in the system allow to use different solutions when in closed position: they can be jutting out, flushed in line, or placed deeper in the window recess
- shutter casement is adapted to use hinges of different manufacturers
- locking elements are also available

TECHNICAL SPECIFICATION	MB-SUNSHADES
Depth of leaf	32 mm
Infill profiles depth	50 mm
Infill profiles distance	every 45 mm
Max. dimensions	1200 × 2500 mm



## WINDOW AND DOOR SYSTEMS **MB-104 PASSIVE**

Thanks to its excellent thermal performances, the thermally broken window and door system **MB-104 PASSIVE** meets all the requirements for the components used in passive buildings. This was confirmed by certificates granted by the Passive House Institute PHI Darmstadt. This system is intended for fabrication of external structure elements such as various types of windows, doors, shop fronts and spatial structures, which are highly resistant and characterized by excellent water & air tightness, and thermal & acoustic insulation performance.

$U_w$  from 0.59 W/(m<sup>2</sup>K)\*



Dedicated windows for energy-efficient homes and Passivhauses

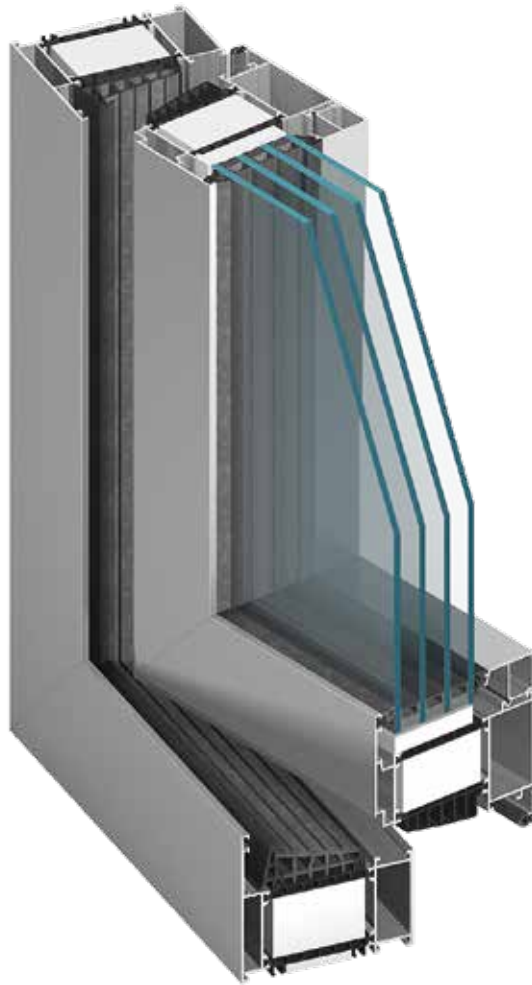

Window MB-104 PASSIVE Aero



Door MB-104 PASSIVE SI

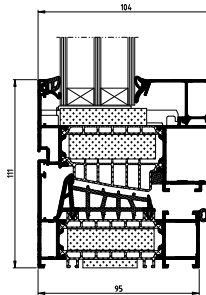

MB-104 PASSIVE Aero opening window – cross-section

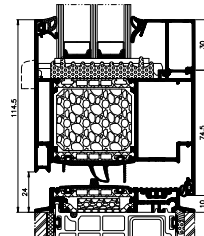

MB-104 PASSIVE SI door – cross-section

## FEATURES AND BENEFITS

- the MB-104 PASSIVE SI and MB-104 PASSIVE Aero windows and doors hold certificates from the Passive House Institute in Darmstadt, Germany
- high thermal insulation parameters  $U_w$  from  $0.59 \text{ W}/(\text{m}^2\text{K})^*$  for windows and a  $U_D$  starting at  $0.66 \text{ W}/(\text{m}^2\text{K})$  for doors\*\*\*
- airtightness, watertightness and insulation parameters surpassing the applicable standards
- wide range of glazing, up to 81 mm allowing for triple and fourfold glazing units
- “Euro” grooves allow the fitting of most of the available hardware, both for aluminium and PVC windows
- can use surface, roller or concealed hinges
- expansion joint profiles for the door leaf
- 95 mm-wide threshold – the threshold and the frame have the same width



TECHNICAL SPECIFICATION	WINDOWS MB-104 PASSIVE	DOOR MB-104 PASSIVE
Depth of frame	95 mm	95 mm
Depth of leaf	104 mm	95 mm
Glazing range	frame: 27 – 72 mm, vent: 34.5 – 81 mm	27 – 72 mm
MAX DIMENSIONS OF THE CONSTRUCTION		
Max. size of leaf (H×W)	H to 2900 mm, W to 1700 mm	H to 3000 mm, W to 1400 mm

PERFORMANCE	WINDOWS MB-104 PASSIVE	DOOR MB-104 PASSIVE
Air Permeability	class 4, EN 12207	class 4, EN 12207
Watertightness	to class AE 3600**, EN 12208	class E1500 Pa, EN 12208
Thermal insulation	$U_w$ from $0.59 \text{ W}/(\text{m}^2\text{K})^*$ $U_w$ from $0.62 \text{ W}/(\text{m}^2\text{K})^{**}$	$U_D$ from $0.66 \text{ W}/(\text{m}^2\text{K})^{***}$
Windload resistance	class C5/B5, EN 12210	class C4/B5, EN 12210

\* -  $U_w$  for MB-104 PASSIVE Aero-based fixed window casement size  $1700 \times 2900 \text{ mm}$ , with glazing  $U_g=0.5 \text{ W}/(\text{m}^2\text{K})$

\*\* -  $U_w$  for MB-104 PASSIVE Aero-based openable window casement size  $1700 \times 2150 \text{ mm}$ , with glazing  $U_g=0.5 \text{ W}/(\text{m}^2\text{K})$

\*\*\* -  $U_D$  for MB-104 PASSIVE Aero door size  $1400 \times 3000 \text{ mm}$ , with glazing  $U_g=0.5 \text{ W}/(\text{m}^2\text{K})$



## WINDOW AND DOOR SYSTEMS

# MB-86N MB-86B MB-86US MB-86 CASEMENT

The highly efficient **MB-86N** window and door system makes it possible to satisfy the diverse needs of users. There are two versions of the profiles, the ST and the SI, which are designed to meet different thermal energy efficiency requirements. The system provides superb performance parameters. Another advantage of the **MB-86N** is the high durability of the profiles, which make it possible to produce large-scale and heavy structures. Several versions are available. The **MB-86US** is a window with a concealed vent. The **MB-86 CASEMENT** provides an outward-opening window with a thermal break. The **MB-86B** has been developed to meet the requirements of the Belgian market.

$U_w$  from 0.62 W/(m<sup>2</sup>K)\*



Stay warm for years to come

**MB-86N SI**

**MB-86B**

**MB-86US**

**MB-86 CASEMENT**

## FEATURES AND BENEFITS

- wide range of profiles guarantees the desired aesthetics and resistance
- with its new shape, wide thermal breaks allow the use of an additional barrier in the profiles' insulation zone
- two-component, central gasket seals perfectly and thermally insulates the space between the casement and the frame
- glazing strips with additional sealing, comes in three versions: Standard, Prestige and Style
- profiles' shapes are well adapted to numerous multi-point locking systems, including concealed hinges
- a wide range of glazing allows the use of all common types of windows triple glazing units, acoustic or security panes
- profiles' drainage functionality is available in two versions: traditional and concealed
- MB-86 CASEMENT outward-opening window
- MB-86US window, featuring invisible casement when looking from outside
- MB-86B has been awarded with certification ATG by the Belgian Research Institute UBAtc.



TECHNICAL SPECIFICATION	MB-86N	MB-86B	MB-86US	MB-86 CASEMENT
<b>PROFILES DIMENSIONS</b>				
Depth of frame (window / door)	77 mm / 77 mm	77 mm / 77 mm	77 mm	77 mm
Depth of leaf (window / door)	86 mm / 77 mm	86 mm / 77 mm	80,8 mm	77 mm
Glazing range (window / door)	frame: 8.5 to 61 mm leaf: 17.5 to 70 mm / frame: 8.5 to 61 mm	frame: 13 to 61 mm leaf: 21 to 70.5 mm / frame: 13 to 61 mm	frame: from 7 to 52 mm leaf: from 15 to 60 mm	frame: from 13 to 61 mm leaf: from 22 to 70 mm
<b>SIZE LIMITATIONS</b>				
Max. size (H×W) (window / door)	H to 3000 mm, W to 1700 mm / H to 3000 mm, W to 1400 mm	H to 2500 mm W to 1500 mm / H to 2600 mm W to 1400 mm	H to 2500 mm, W to 1600 mm	H to 2500 mm W to 2400 mm / H to 2800 mm W to 1400 mm
Solutions	fixed window, side-hung window, hopper window, tilt-and-turn window, single & double outward and inward openable door		fixed window, side-hung window, hopper window, tilt-and-turn window	fixed, side-hung, awning and bottom-hung

PERFORMANCE	MB-86N	MB-86B	MB-86US	MB-86 CASEMENT
Air Permeability	class 4, EN 12207	class 4, EN 12207	class 4, EN 12207	class 4, EN 12207
Watertightness	class E 4800*, EN 12208, class E1500, EN 12208 / class E1350 Pa	class 9A, EN 12208 / class 6A, EN 12208	class E 1350, EN 12208	E1950 Pa, EN 12208
Thermal insulation	$U_w$ from 0,62 W/(m <sup>2</sup> K)* $U_w$ from 0,68 W/(m <sup>2</sup> K)** $U_D$ from 0,80 W/(m <sup>2</sup> K)***	—	—	—
Windload resistance	class CE3330 (3330Pa) EN 12210 / class C5 (2000Pa), class B5 (2000Pa) EN 12210	class C4, EN 12210 / class C5, EN 12210	class C5, EN 12210	C5, EN 12210
Impact resistance	—	class 3 / class 3	—	class 3 / class 3

\* -  $U_w$  for MB-86N SI-based fixed window casement size 1700×2800 mm, with glazing  $U_g=0,5$  W/(m<sup>2</sup>K)

\*\* -  $U_w$  for MB-86N SI-based openable window casement size 1700×2150 mm, with glazing  $U_g=0,5$  W/(m<sup>2</sup>K)

\*\*\* -  $U_D$  for MB-86N SI+ door size 1400×3000 mm, with glazing  $U_g=0,5$  W/(m<sup>2</sup>K)



## FOLDING DOOR **MB-86 FOLD LINE HD**

Exterior folding door offers greater flexibility to its users. It enables us to use weather conditions to our advantage and virtually eliminate the barrier between the interior space and its surroundings. Such door can perfectly combine the interior space (home, café, restaurant) with the terrace or the outside area that is used seasonally.

With its excellent technical parameters, **MB-86 FOLD LINE HD** is a very convenient solution that enables the fabrication of large-dimension structures. Folding door can be opened both outwards and inwards and its leaves can be freely configured. It's a modern product, designed to meet the high demands of users, architects and owners.

excellent thermal insulation



Make the natural environment part of your daily experience



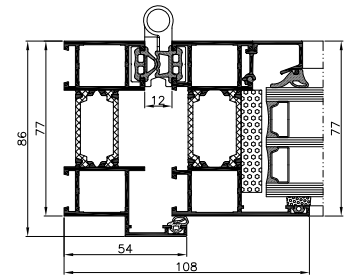
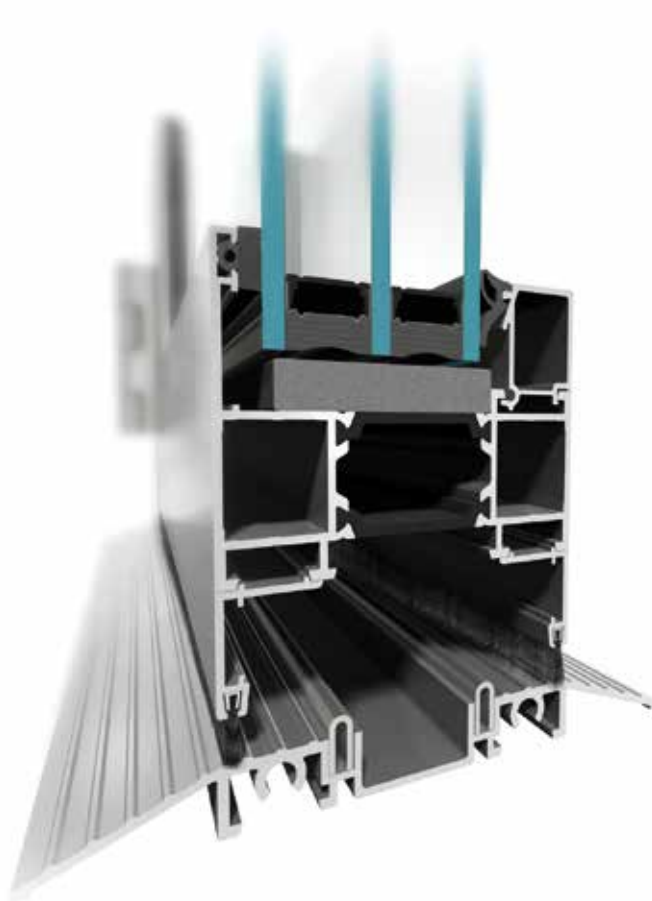

door, side view

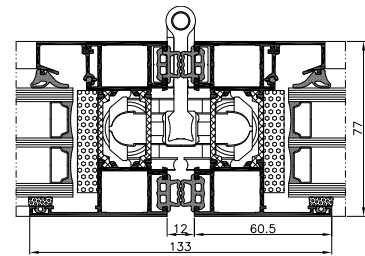

door/leaves, view

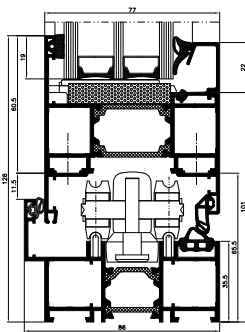

door with edge sealing, bottom view

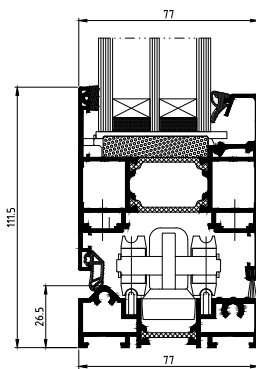

bottom cross-section of a door with low threshold

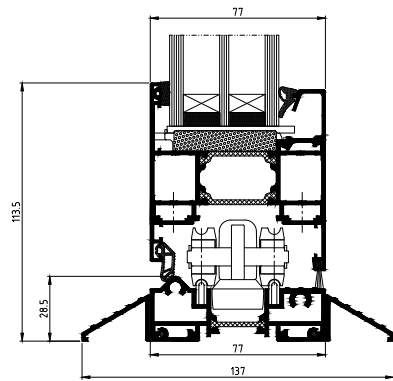

door with low-level threshold, bottom view

## FEATURES AND BENEFITS

- three-chambered, durable aluminium profiles of a structural depth of 86 mm for frames and 77 mm for door leaves
- it is available as a corner or panoramic structure and can be assembled with up to eight panels
- central chamber of the profiles is equipped with thermal break (24 mm-wide for frames and 34 mm-wide for door leaves) providing excellent thermal insulation performance.
- specialized and dedicated hardware for MB-86 FOLD LINE HD ensures comfortable operation of the door leaves of a maximum weight of up to 120 kg
- large dimensions of the construction enable the fabrication of doors that are up to 3000 mm high and 700 to 1200 mm wide
- it features the widest range of threshold solutions, including one which provides a weatherstrip and another which offers a low threshold for even more user comfort
- threshold solutions in different versions: classic, with edge sealing or convenient, with a hidden threshold
- a large range of glazing from 14 to 61.5 mm to enable the use of single and double glass units, including specialized, more performant units in terms of sound insulation or burglary resistance
- important degree of compatibility with the well-known and highly appreciated window & door system ALUPROF MB-86: profiles are jointed the same way, and some profiles, gaskets and accessories are common to both systems

Secured by Design





# PANEL DOOR

**Panelled door's** design is based on the MB-70, MB-79N, MB-86N and MB-104 PASSIVE thermally insulated aluminium doors and is available in four versions, each with different frame and leaf profiles construction. As infills, the door uses highest quality decorative panels, available in a wide range of designs and colours, which can be glued to the door profiles on.

The **panelled door** combines a high level of aesthetics and excellent thermal and acoustic insulation. The use of self-cleaning paints makes them look very pretty and stylish for a long time. Aluprof **panelled door** is a solution for the most demanding users, to whom a door means not only safety and durability, but is also a matter of pride and aesthetic pleasure.

durability and aesthetic in your house



Comfort is just a step away

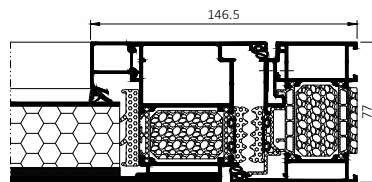
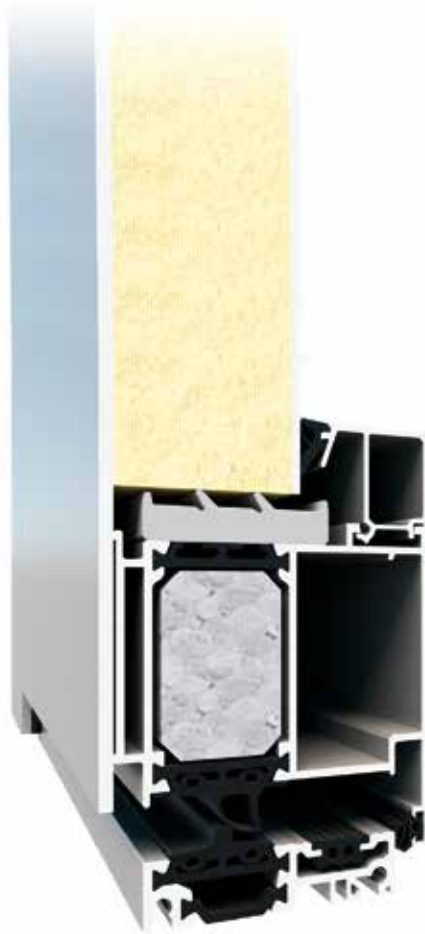

cross-section through the MB-86N SI+ panel door in the storefront building

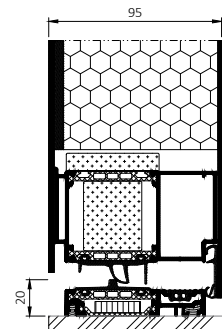

cross through the threshold of the panel door MB-104 PASSIVE Aero

## FEATURES AND BENEFITS

- a solid structure based on ALUPROF's thermally insulated, MB-70, MB-79N, MB-86N and MB-104 PASSIVE, aluminium profiles
- door leaf expansion joints
- top-end hardware
- the perimeter of the leaf and frame are fitted with seals which enhance the thermal properties of the door
- a wide selection of state-of-the-art, aluminium panels with high thermal insulation parameters
- a contemporary and stylish look which will stay in vogue for years, available in a range of designs and colours
- first-class airtightness, watertightness and insulation parameters
- the system can be used to build large-scale structures

TECHNICAL SPECIFICATION	PANEL DOOR MB-70	PANEL DOOR MB-79N	PANEL DOOR MB-86N	PANEL DOOR MB-104 PASSIVE
Frame depth	70 mm	70 mm	77 mm	95 mm
Leaf depth	70 mm	70 mm	77 mm	95 mm
Filling panel thickness	44 - 70 mm	44 - 70 mm	44 - 77 mm	to 95 mm
Max. leaf dimensions (H×W)	H to 2400 mm, W to 1200 mm	H to 2600 mm, W to 1400 mm	H to 2600 mm, W to 1400 mm	H to 2600 mm, W to 1400 mm



## WINDOW AND DOOR SYSTEMS

# MB-79N MB-79N CASEMENT

The **MB-79N** is a state-of-the-art and economical addition to the Aluprof window & door systems. It has been designed to outperform typical thermal insulation requirements. The **MB-79N** series can be used to fabricate fixed, side-hung, hopper, tilt-and-turn, and hopper-and-slide windows, as well as single and double exterior doors, and storefront solutions complete with doors. In addition to the economical version **MB-79N E**, featuring a one-component central seal, and the **MB-79N ST** version with a two-component central seal, Aluprof also offers the **MB-79N SI** variant with enhanced thermal insulation, and with profiles that come equipped with insulating inserts and a two-component central seal. For external doors, Aluprof also offers the **MB-79N SI+** variant that comes with a central seal and insulating inserts inside the profiles. In addition, this product range features the **MB-79N CASEMENT** system for outward-opening windows with a thermal break.

**$U_w$  from 0.64 W/(m<sup>2</sup>K)\***



An innovative window and door system

**MB-79N E window**

**MB-79N ST window**

**MB-79N SI+ door**

**MB-79N CASEMENT**

## FEATURES AND AESTHETICS

- profile depth: 79 mm (casement) and 70 mm (window frame and door leaf)
- thermal breaks made of an innovative material with a brand-new shape allow the use of a seal in the area of profile insulation, in both windows and doors
- windows in 3 thermal variants (MB-79N E, MB-79N ST, MB-79N SI) and doors in 3 thermal variants (MB-79N ST, MB-79N SI and MB-79N SI+)
- at 0.9 W/(m<sup>2</sup>K) for the windows and 1.3 W/(m<sup>2</sup>K) for the doors, the structure meets the Technical Requirements applicable as of 2021
- thermal insulation:  $U_w$  starting from 0.64 W/(m<sup>2</sup>K)
- excellent kinematics enabling the fabrication of narrow, operable windows
- door leaf profiles have isolation joint, which eliminates thermal stresses during operation
- possibility of using invisible hinges and the most popular multi-point hardware, including hidden fittings + state-of-the art AluPilot fittings; for doors, fittings with automation and access control functions are also available
- able to receive double or triple glazing, up to 63 mm for windows and 54 mm for doors, thus making it possible to use all common types of glass, including acoustic or burglar-resistant glass
- possibility to produce security doors rated RC1 – RC3, and panel doors in many highly aesthetic versions
- large selection & different styles of handles, including minimalist looking handles with or without rosette
- the MB-79N CASEMENT variant, with outward-opening windows and a thermal break is also available

TECHNICAL SPECIFICATION	MB-79N WINDOWS	MB-79N DOORS
Frame depth	70 mm	70 mm
Casement depth	79 mm	70 mm
Glazing thickness	frame: 1.5 – 54 mm, casement: 10.5 – 63 mm	frame: 1.5 – 54 mm
Max. casement size (H×L)	H up to 2700 mm, L up to 1350 mm H up to 2150 mm, L up to 1700 mm	H to 2800 mm, L to 1400 mm

PERFORMANCE	MB-79N WINDOWS	MB-79N DOORS
Air permeability	class 4, EN 12207	class 4, EN 12207
Water tightness	class E 1950, EN 12208	class E900 (900 Pa), EN 12208
Thermal insulation	$U_w$ from 0,64 W/(m <sup>2</sup> K)* $U_w$ from 0,72 W/(m <sup>2</sup> K)**	$U_D$ from 0,90 W/(m <sup>2</sup> K)***
Resistance to wind load	class C5, EN 12210	class C5/B5, EN 12210

\* -  $U_w$  for MB-79N SI-based fixed window casement size 1700×2700 mm, with glazing  $U_g=0,5$  W/(m<sup>2</sup>K)

\*\* -  $U_w$  for MB-79N SI-based openable window casement size 1700×2150 mm, with glazing  $U_g=0,5$  W/(m<sup>2</sup>K)

\*\*\* -  $U_D$  for MB-79N SI+ door size 1400×2800 mm, with glazing  $U_g=0,5$  W/(m<sup>2</sup>K)



## DOOR AND WINDOW SYSTEMS

# MB-70 MB-70B MB-70US

This aluminium system is intended for fabrication of various thermal & sound insulated external structures: windows, doors, entrance enclosures, shop fronts and spatial structures. It features a version with enhanced thermal insulation obtained thanks to special insulating inserts inside the profiles and in the under-the-glass area. **MB-70** allows for fabrication of burglar-resistant windows & doors up to class RC4 plus smoke exhaust windows. Various types of windows including "concealed sash-windows" MB-70US / MB-70US HI, MB-70SG plus a version for historic buildings MB-70 Industrial. The system is also a base for MB-70CW / MB-70CW HI-based "cold-warm" curtain wall. The **MB-70B** is designed to meet the needs of the Belgian market.

$U_w$  from 1.0 W/(m<sup>2</sup>K)

**RECOMMENDED  
FOR ENERGY-EFFICIENT  
CONSTRUCTIONS**



**AQUARIUS BUSINESS HOUSE**

Location: Wrocław / Poland / Design: Arcad Sp. z o.o. S.K.A.

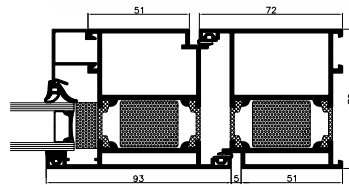
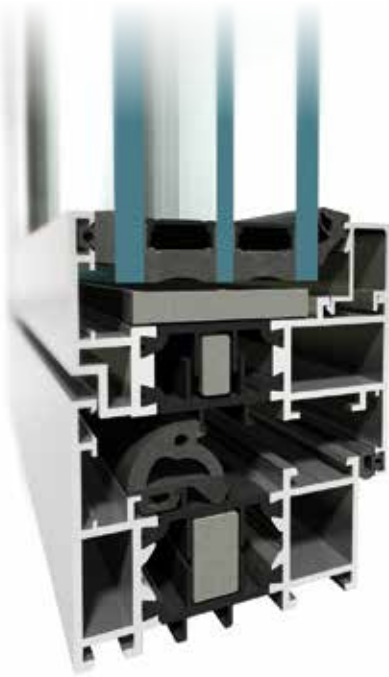
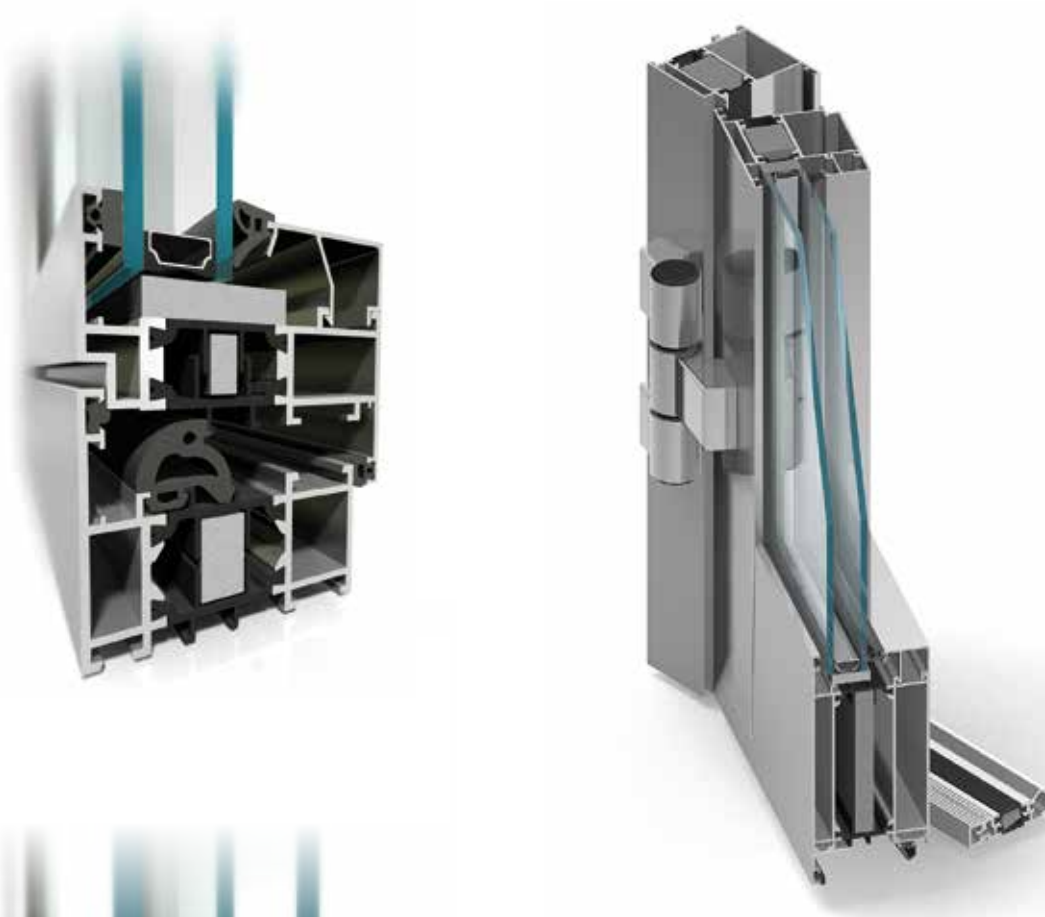

MB-70HI Door – cross-section

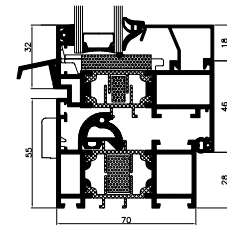

MB-70HI Window – cross-section

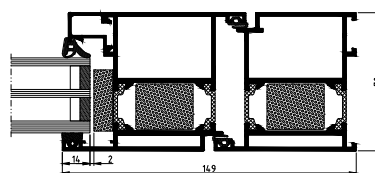

MB-70B Door – cross section

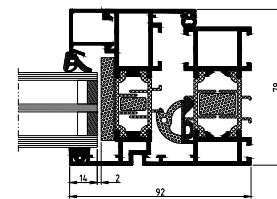

MB-70B Window – cross section

## FEATURES AND BENEFITS

- variety of functions, tailored to users' needs
- possibility to bend profiles, and to create arch structures
- variety of aesthetic solutions offered by windows with concealed sash, Industrial "steel-like" variant and three types of glazing beads: Standard, Prestige, Style
- outward or inward openable single/double doors including "safe stop" doors
- structures suited to different types of hardware, including concealed hinges in windows and roller hinges in doors
- basis for solutions with enhanced thermal insulation: MB-70HI, MB-70US HI and MB-70CW HI
- possibility of fabricating two-colour constructions: profiles can have different colours on external and internal side
- compliance with CE marking requirements
- MB-70B has been awarded with certification ATG by the Belgian Research Institute UBAtc.



## MB-70US MB-70US HI

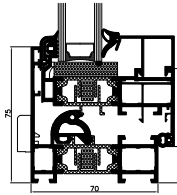

opening window  
- cross-section

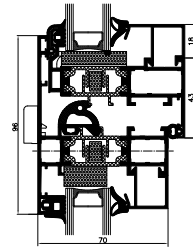

opening window and fixed window  
- cross-section

The invisible window sash variety. It enables an effect of indifferent look of series of neighboring combination of fixed and opening windows from the outside of the building. It gives an impression of light and neat look since low width of frames seen from the outside. Available in both regular and HI variety with enhanced thermal insulation.

## MB-70SG

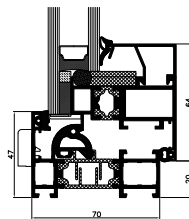

opening window  
- cross-section

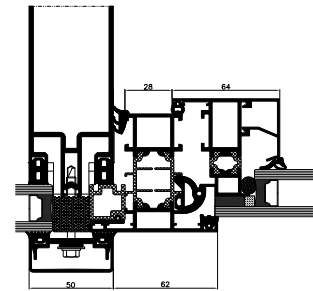

active window in a curtain wall  
- cross-section

The variety of system that enables to make window with sash invisible from the outer space. It resembles regular concealed sash construction but since its frame features 47 mm width it is therefore narrower than MB-70US and offers slimmer and lighter look.

## MB-70 INDUSTRIAL MB-70 INDUSTRIAL HI

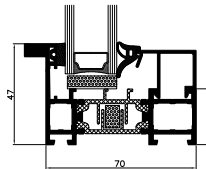

fixed window  
- cross-section

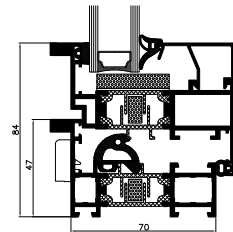

opening window  
- cross-section

Whether for renovating old steel windows or giving a stylish steel look to new-build, the MB-70 Industrial enables to keep with the original style, providing all the benefits of modern aluminum technology. Combining attractive design options with long term reliability, the system also features enhanced thermal insulation properties to ensure energy conservation.

## MB-70 CASEMENT MB-70 CASEMENT HI

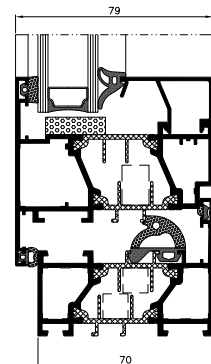

opening window  
- cross-section

Hardware used in MB-70 CASEMENT outward-opening or awning windows can consist both of typical roller hinge or knife hinge, allowing for entire window casement to be moved away from the frame. Unlike inward-opening windows, outward-opening constructions have an important feature: wind pressure does not have an adverse effect on their tightness, as it presses the casement against the frame. This product is available in a variant with enhanced thermal insulation - MB-70 CASEMENT HI.



## MB-70CW MB-70CW HI

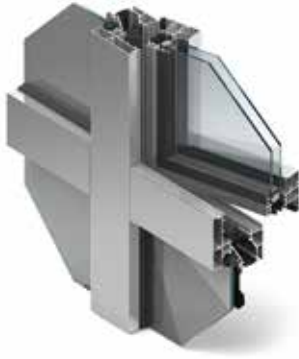

This solution is used for reinforced concrete or brick external wall developments with window openings. This curtain wall includes two types of zones: "cold" and "warm". "Warm" zones are thermally insulated windows installed in front of the façade, in window openings. "Cold" zones are intra-window areas made of non-thermally insulated profiles and single panes that protect the construction and its thermal insulation (eg. mineral wool) against adverse weathering conditions.

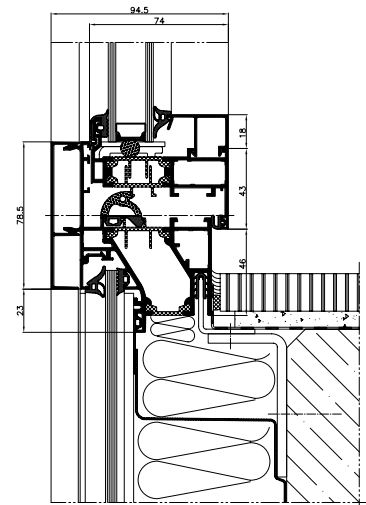

cross-section  
of an active window

TECHNICAL SPECIFICATION	MB-70 MB-70HI	MB-70US MB-70US HI	MB-70 Industrial MB-70 Industrial HI	MB-70SG	MB-70CW MB-70CW HI	MB-70B	MB-70 CASEMENT MB-70 CASEMENT HI
Depth of frame (door / window)	70 mm / 70 mm	70 mm				70 mm / 70 mm	70 mm
Depth of leaf (door / window)	70 mm / 79 mm	79 mm				79 mm / 70 mm	79 mm
Glazing range (fixed window and door / opening window)	15 – 54 mm / 23 – 62 mm	9 – 45 mm / 18 – 54 mm	15 – 54 mm / 23 – 62 mm	18 – 54 mm	9 – 45 mm / 18 – 54 mm	14.5 – 53.5 mm / 23.5 – 62 mm	14.5 – 53.5 mm / 23.5 – 62 mm
<b>MIN VISIBLE WIDTH T PROFILE</b>							
Door / window frame	51 mm / 47 mm	75 mm	47 mm	47 mm	78.5 mm	51 mm / 47 mm	28 mm
Door / window leaf	72 mm / 32 mm	—	32 mm	—	34.6 mm	72 mm / 32 mm	75.5 mm
<b>SIZE LIMITATIONS</b>							
Opening window (H×W)	H to 2400 mm W to 1600 mm	H to 2100 mm W to 1400 mm	—	H to 2400 mm W to 2000 mm	H to 2100 mm W to 1400 mm	H to 2400 mm W to 1600 mm	H to 2600 mm W to 2400 mm
Door (H×W)	H to 2400 mm W to 1300 mm	—	—	—	—	H to 2374 mm W to 1100 mm	—
<b>TYPES OF CONSTRUCTION</b>							
Solutions	tilt window, turn window, tilt&turn window, doors open in and open out	fixed window, tilt window, turn window, tilt&turn window	fixed window, tilt&turn window	turn window, tilt window, tilt&turn window	fixed window, tilt&turn window	tilt window, turn window, tilt&turn window, doors open in and open out	fixed window, tilt&turn window open out and top-hung casement window

PERFORMANCE	MB-70 MB-70HI	MB-70US MB-70US HI	MB-70 Industrial MB-70 Industrial HI	MB-70SG	MB-70CW MB-70CW HI	MB-70B	MB-70 CASEMENT MB-70 CASEMENT HI
Air Permeability	class 4, EN 1026; EN 12207					class 4, EN 1026; EN 12207	class 4, EN 1026; EN 12207
Watertightness	to class E1200 EN 1027; EN 12208			E750 EN 1027; EN 12208		9A, EN 1027; EN 12208	to class E1500 EN 1027; EN 12208
Windload resistance	to class C5 / EN 12211; EN 12210			class C5 EN 12211; EN 12210		to class C3, EN 12211; EN 12210	to class C4 (2400 Pa), EN 12211; EN 12210

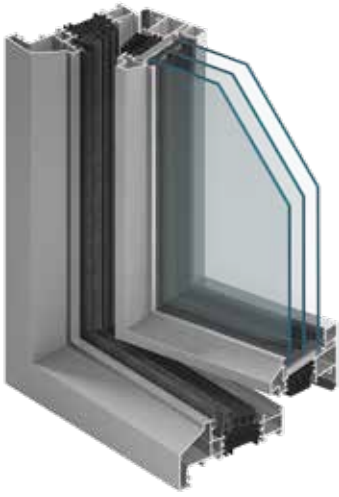

## WINDOW SYSTEM WITH SLIM PROFILES **MB-FERROLINE**

The new window system with thermal break **MB-FERROLINE** is perfectly suitable for renovation of historic buildings and helps to preserve the appropriate appearance of windows, which can imitate steel joinery, whilst ensuring very good technical performance of the construction. The system enables the fabrication of various types of highly resistant, inward opening windows (side-hung, hopper, tilt-and-turn windows), outward opening windows (side-hung and top hung windows) and fixed windows of an excellent water resistance, air tightness, and sound insulation performance.

Several types of profile appearance are offered. Renovation frames available within the system enable for installation of new constructions without having to disassemble the old frames, and there is no risk of damage to the surrounding wall. The adjusted, visible width of aluminium profiles makes the old and new windows look virtually identical. Based on reliable solutions and offering a whole range of appropriately shaped new profiles, **MB-FERROLINE** enables the fabrication of constructions that fit the appearance of the building.

wide range of solutions

high thermal insulation



The new edition of the traditional design

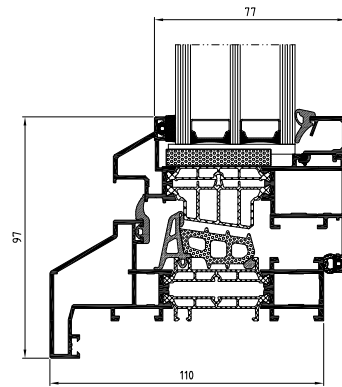
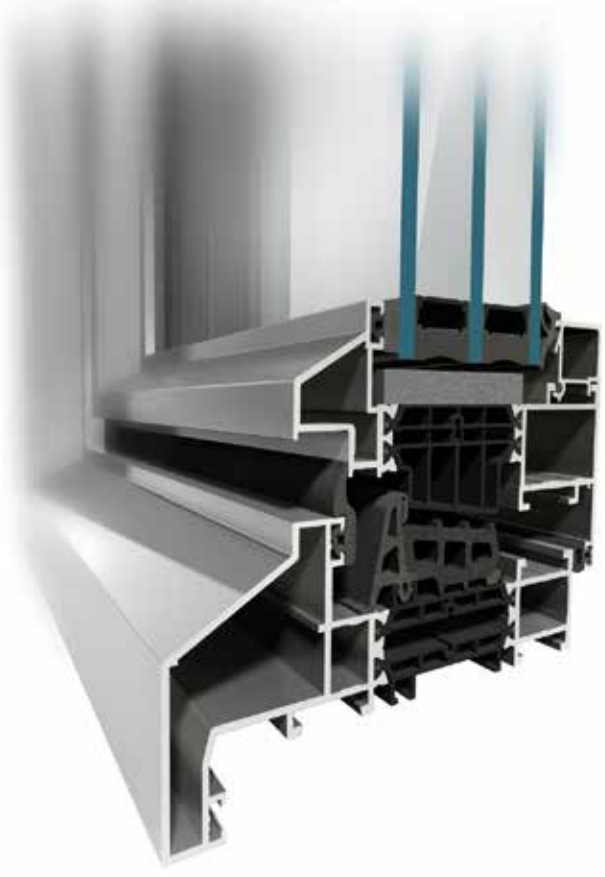

openable window with renovation frame  
- cross-section

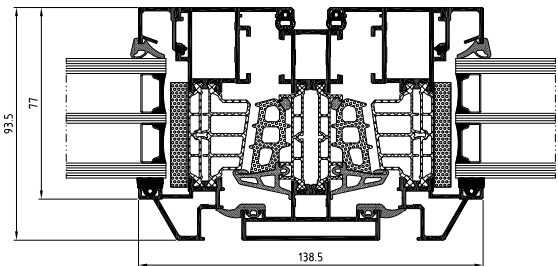

window transom & openable windows  
- cross-section

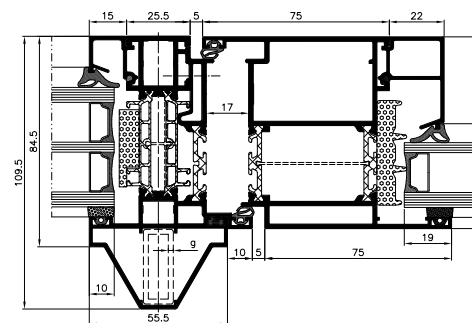

cross-section of a door

## FEATURES AND BENEFITS

- classical appearance
- MB-86N-based technical solutions ensure an excellent thermal protection of the construction, profiles come in two versions with different thermal insulation performance: ST and SI
- high resistance to water & air infiltration
- wide range of glazing up to 61.5 mm
- a structure with a burglar resistance class of up to RC2 can be built
- application of the typical euro grooves enable the installation of most of the available fittings offered by major companies

TECHNICAL SPECIFICATION	MB-FERROLINE
Depth of frame	77 mm – 110 mm
Depth of leaf	86 mm – 93.5 mm
Glazing range: frame / leaf	13.5 mm – 61.5 mm

PERFORMANCE	MB-FERROLINE
Air Permeability	class 4, EN 12207
Watertightness	to class E1350, EN 12208
Wind load resistance	to class C5, EN 12210



## WINDOW SYSTEM WITH SLIM PROFILES **MB-SLIMLINE**

Highly insulated, **MB-SLIMLINE** window system with thermal break is intended for fabrication of external structure elements such as various types of highly resistant, inward-openable windows (side-hung, hopper, tilt-and-turn windows) and fixed windows of an excellent water resistance, air tightness, and sound insulation performance.

With its very small-width aluminium profiles, visible from the external side of the construction, **MB-SLIMLINE** enables to fabricate casements in two variants – with visible or invisible profiles (SG) from the external side of the structure. When invisible casements are used, the appearance of openable and fixed units is almost identical.

This system can also greatly replace the old-style windows, made of steel profiles and maintain a similar appearance from the outside of the construction, while significantly increasing the thermal insulation of the partition.

**U<sub>w</sub> from 0.8 W/(m<sup>2</sup>K)\***



Traditional look with a modern twist

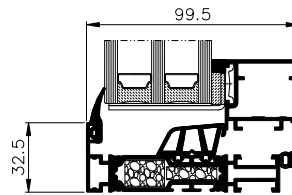

opening window  
- cross-section

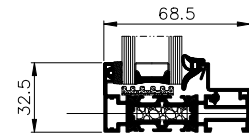

fixed window  
- cross section

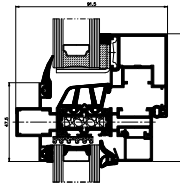

fixed and opening window  
- cross section

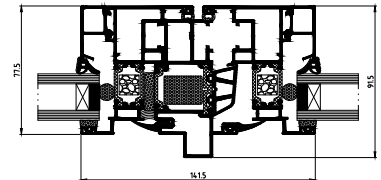

window cross-section  
- floating mullion

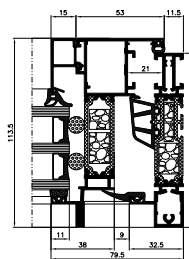

opening window  
- cross section

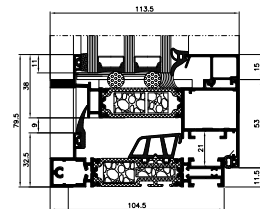

opening window  
- cross section

## FEATURES AND BENEFITS

- high resistance to water & air infiltration plus an excellent thermal insulation can be obtained thanks to the special shape of the central gasket
- good thermal insulation  $U_w$  from  $0.8 \text{ W}/(\text{m}^2\text{K})$
- important glazing range, up to 81 mm
- the use of typical "Euro" grooves enables installation of most of the available fittings
- the construction method is maximally simplified. Profile connections (corner & T-connections) are performed by bolting or studding



TECHNICAL SPECIFICATION	MB-SLIMLINE
<b>PROFILES DIMENTIONS</b>	
Frame depth	68.5 – 123.5 mm / 90.5 – 145.5 mm
Sash depth	77.5 mm / 99.5 mm
<b>A RANGE OF GLAZING</b>	
Fixed / opened window for 68,5 mm frame	8 – 50 mm / 17 – 59 mm
Fixed / opened window for 90,5 mm frame	30 – 72 mm / 39 – 81 mm
<b>SIZE AND WEIGHT LIMITATIONS</b>	
Max. size of window (H×W)	H to 2400 mm, W to 1400 mm H to 2100 mm, W to 1600 mm
Max. weight of sash	150 kg

PERFORMANCE	MB-SLIMLINE
Air Permeability	class 4, EN 1026:2001; EN 12207:2001
Watertightness	class E 1500, EN 1027:2001; EN 12208:2001
Thermal insulation	$U_w$ from $0.8 \text{ W}/(\text{m}^2\text{K})^*$

\* - Heat transfer coefficients for single chamber glazing units with a plastic spacer amount to  $U_w \geq 1.3 \text{ W}/(\text{m}^2\text{K})$ , and to the excellent value of  $U_w \geq 0.8 \text{ W}/(\text{m}^2\text{K})$  for double chamber glazing units.

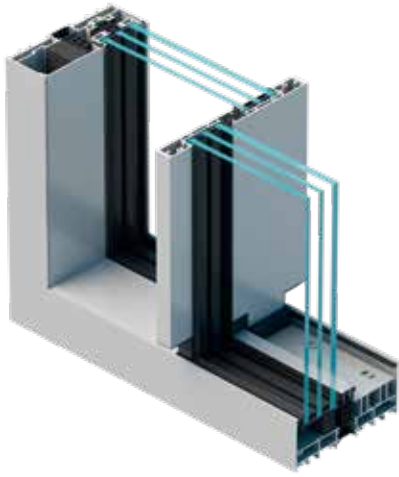

## PANORAMIC SLIDING DOOR WITH CONCEALED FRAME **MB-SKYLINE TYPE R**

The ALUPROF **MB-SKYLINE TYPE R** is a cutting-edge, large-scale, sliding door system which makes a feature of lightness and aesthetics. Slender profiles simultaneously provide both a contemporary look and a panoramic view of the surroundings. The main features of the **MB-SKYLINE TYPE R** are the completely invisible profile of the door leaf, the slender mullion and the shallow frame, all of which will be appreciated at the very first glance. The leaves may be massive, but no great effort is required to slide them open and closed and the mechanism that operates them is almost soundless. The maximum height for a structure based on the system is no less than four metres and, if the drive is fitted on the outside rather than being hidden, then the moving leaf can weigh as much as seven hundred kilos. This affords the possibility of designing spectacular glass walls. Doors created using the **MB-SKYLINE TYPE R** give a building an exceptional style and enhance the status of an entire development.

a maximum leaf weight of 1200 kg



A luxurious way out into the garden

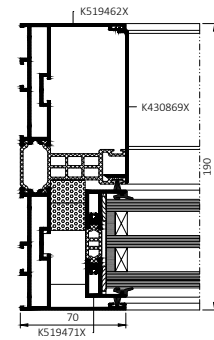
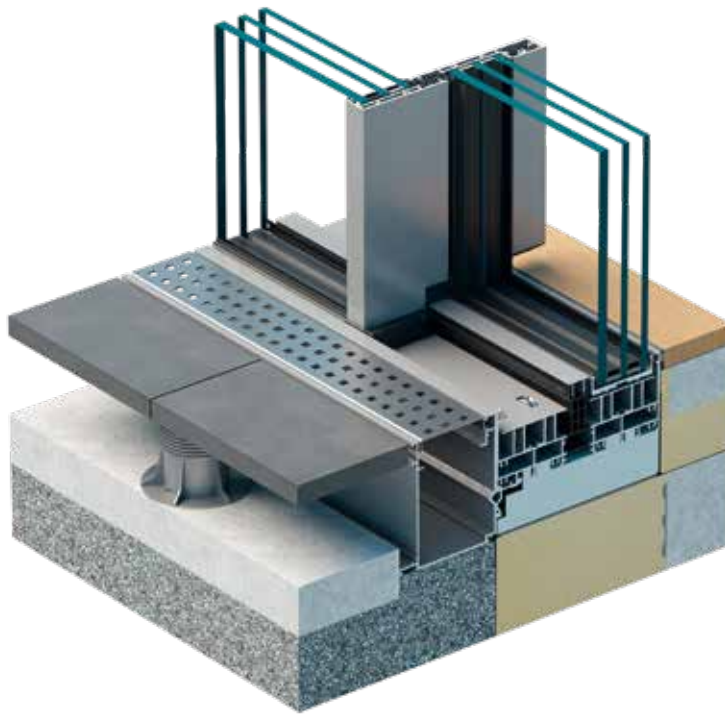

cross section of the side of the door

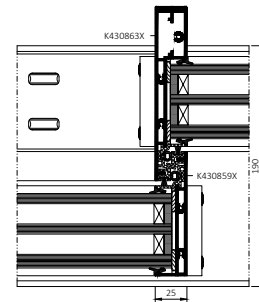

cross section of the door-leaf intersection point

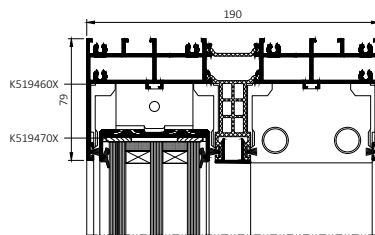

cross section of the top of the door

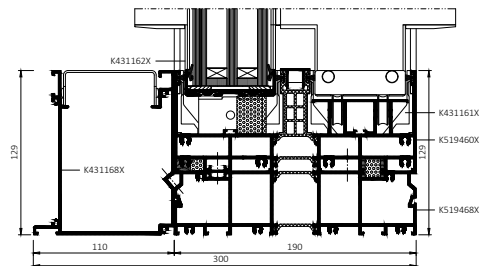

cross section of the bottom of the door

## FUNCTIONS AND AESTHETICS

- the door frame is built into the walls, floors and ceiling
- the leaf profiles are completely hidden in the upper and lower frames when the automatic drive unit option is selected, or the mullion features a locking mechanism, the leaf profiles remain invisible at the sides of the structure
- the width of the mullion where the leaves meet is 25 mm
- a slender, symmetrical, three-light structure with an operable central section (type G), which is also available for the manually operated version
- a convenient, shallow, 23-mm-deep frame
- the maximum panel weight is 500 kg for manually operated panels and 1200 kg for automatically operated
- the glazing ranges from 52 to 60 mm
- the structural depth of the door profiles is 71 mm for the leaves and 190 mm for the frame
- the door leaves are made using state-of-the-art insulation material with high thermal parameters
- the cutting-edge sliding seals used in the frame are aesthetically pleasing and silent in use
- the rollers the leaf moves along are available in stainless steel or black polyamide
- there are two locking options; manual, using BT Lock hardware or fitted to the mullion
- the exterior drive is equipped with a radio receiver and security radar. The door also features a state-of-the-art drainage system, complete with guttering, and system brackets with height regulation
- the structural base has excellent thermal insulation
- the system features a 'zero mullion', which makes it possible to use external venetian and roller blinds like the ALUPROF Skyflow and Skyroll

PERFORMANCE	MB-SKYLINE TYPE R
Air Permeability	class 4 PN EN 12207
Watertightness	class 8A (450 Pa) PN EN 12208
Windload resistance	C3 (1200 Pa)/B3 (1200 Pa) PN EN 12210



## PANORAMIC SLIDING DOOR WITH CONCEALED FRAME **MB-SKYLINE**

The **MB-SKYLINE** sliding door system with invisible frame uses narrow profiles. This gives the construction a modern and minimalist look. Constructions fabricated with **MB-SKYLINE** have a one-of-a kind design and raise the profile of any project. They provide a comfortable, threshold-free connection of indoor and outdoor living spaces making natural environment part of users' daily experience. While the doors can be very large, their slim construction gives the impression of lightness and delicacy. The product is uniformly glazed, has slim modulations and perfectly fits into high-end construction market.

the visible connection width of door leaves is 25 mm



The view above all



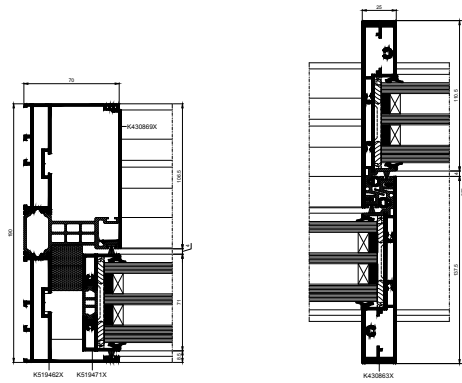
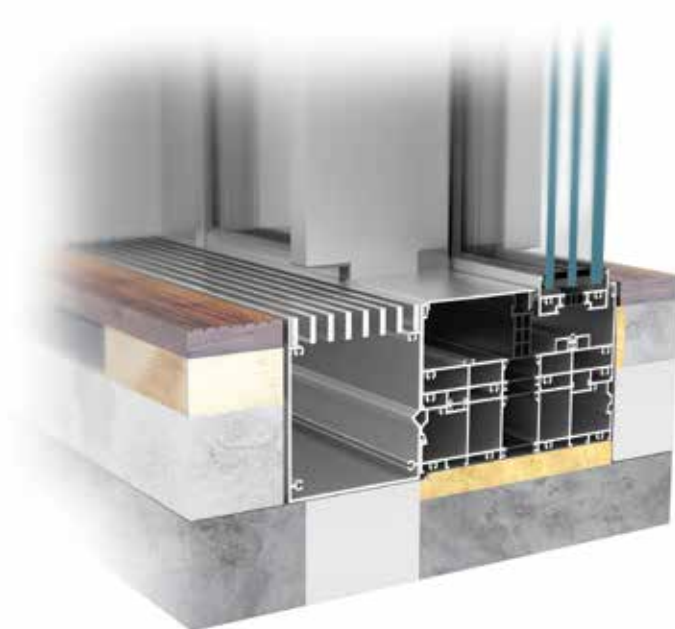

door, side view

door leaves connection, view

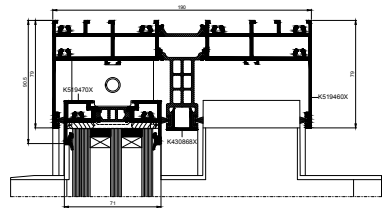

door, top view

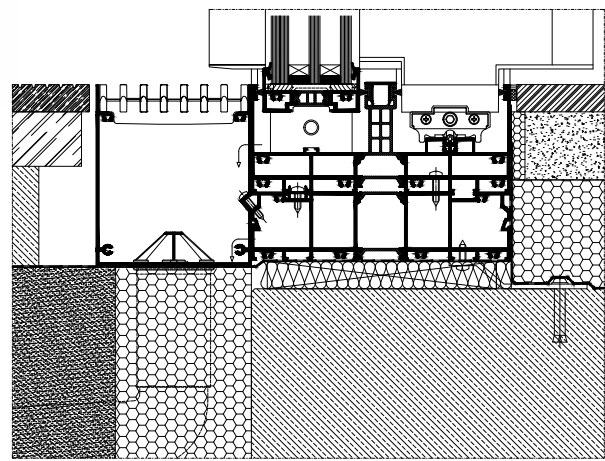

built-in door, bottom view

## FEATURES AND BENEFITS

- 71 mm (door leaf) and 190 mm-deep profiles (2-slide frame)
- modern design and high aesthetics: the frame is concealed in the wall, in the floor and in the ceiling, the frame profile is fully aligned at the sides, the visible connection width of door leaves is 25 mm
- door leaves up to 700 kg and up to 4 m high
- 3-chambered, thermally-insulated profiles
- 52 to 60 mm-thick triple glazing units
- door opens manually or automatically
- drives and control units are concealed in frame profiles
- can use an automatic unit mounted on the outside of the construction

PERFORMANCE	MB-SKYLINE
Air Permeability	class 3, EN 12207
Watertightness	up to class 9A (600Pa), EN 12208
Windload resistance	up to class C5 (2000Pa), EN 12210
Thermal insulation	$U_g$ from 0.85 W/(m <sup>2</sup> K)*

\* - for door leaf 2.07×3.44 m, infilled with triple glazing units  $U_g = 0.5$  W/(m<sup>2</sup>K) and warm spacer



## LIFT AND SLIDE BALCONY DOOR

# MB-77HS MB-77HSB

The **MB-77HS** "Lift & Slide" door product is an ideal solution for connecting interior space rooms or conservatories with the outside balcony, terrace or garden area. Providing both a smooth & silent slide action operation, it can bring the benefits of a beautiful day outside, into the living space. In addition, & by way of its design & operation, the **MB-77HS** is a great space saving opening & does not encroach the free space beyond the internal or external confines of the frame, without any compromise. Providing excellent weather tightness together with enhanced thermal performance, the **MB-77HS** complies with all of the requirements associated with this product type. Available in two different options, with regard to the level of thermal performance, the **MB-77HS** is further categorised as "ST" and "HI" standard or highly insulated. The **MB-77HSB** is designed to meet the needs of the Belgian market.

large sizes constructions with the width over 6 m



Bring the outdoor inside

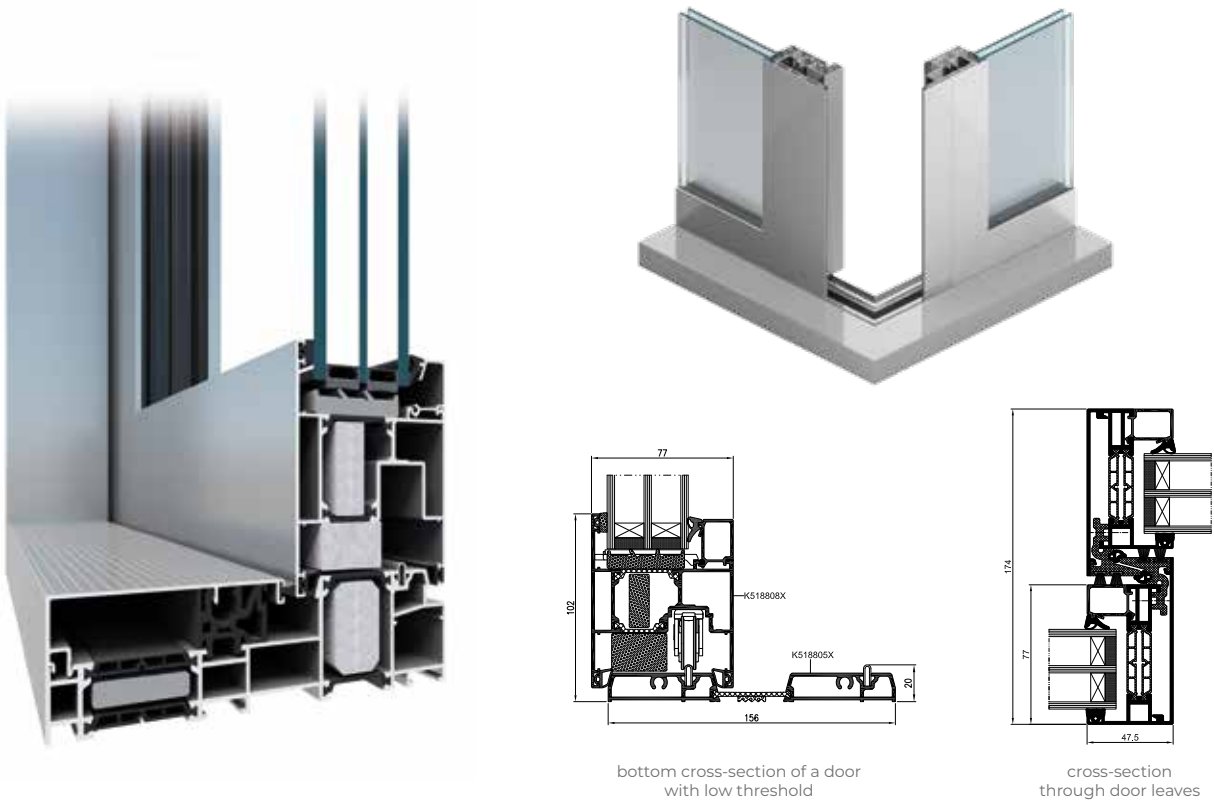

bottom cross-section of a door  
with low threshold

cross-section  
through door leaves

## FEATURES AND BENEFITS

- the slender and durable profile makes it possible to build a low-threshold door weighing up to 600 kg, with a height of up to 3.2 m and a width of up to 3.3 m
- the frames are available in twin-track and triple-track variants
- 90° and 270° corners can be built, creating an exceptionally large space once the door is open
- a slender, 47 mm mullion
- convenient solutions featuring a low threshold
- a wide range of infills, including the use of single- or double-glazed units, as well as thermal breaks, a range of accessories and insulating inserts making it possible to achieve excellent thermal and acoustic parameters
- three styles of glazing beads: Standard, which is rectangular; Prestige, which is rounded; and Style, which is diamond shaped
- the shape of the glazing beads and the break-in prevention details make it possible to obtain increased burglary resistant properties without changing the door's fundamental construction elements of the door
- the special shapes of the stop seals and glazing gaskets, together with the proper hardware, ensure high air- and watertightness
- the profiles are designed to enable the installation of numerous manual and automatic locking devices available on the market
- the MB-77HS features a high level of compatibility with the ALUPROF MB-86N allowing the door to can be aesthetically combined with windows and some of the same parts can be used to build them
- the wide range of colours means that the door can be used freely for the composition of any interior or exterior décor
- the MB-77HSB systems holds a Technical Approval (ATG) certificate issued by the Belgian Union for Technical Approval in Construction (BUTgb/UBAtc)



TECHNICAL SPECIFICATION	MB-77HS / MB-77HS HI	MB-77HSB
Frame depth	174 mm (2-rail profile), 271 mm (3-rail profile)	
Sash depth	77 mm	
Window glazing thickness	13.5 – 58.5 mm	
<b>MIN. WIDTH OF PROFILES</b>		
Frame	48 mm	
Sash	94.5 – 105.5 mm	

PERFORMANCE	MB-77HS / MB-77HS HI	MB-77HSB
Air Permeability	class 4, EN 12207	
Watertightness	class 9A, EN 12208	
Thermal insulation	$U_w$ from 0.84 W/(m <sup>2</sup> K)*	$U_w$ from 0.88 W/(m <sup>2</sup> K)*
Windload resistance	to class C4, EN 12210	to class C2, EN 12210

\*  $U_w$  for MB-77HS HI & MB-77HSB openable window, 3.0×2.9 m, glazing  $U_g=0.5$  W/(m<sup>2</sup>K)

## FOR LIFT & SLIDE DOORS

# MB-59HS



Lift & slide door is the perfect integrating element that connects rooms or winter gardens with external spaces. It provides a convenient exit to the balcony, terrace or garden. When in the open position, the door does not take up space inside the room, whilst enabling a very good contact with the environment which further increases the comfort of use. **MB-59HS** gives you great possibilities in applications of lift & slide doors, and is the optimized solutions in terms of construction and dimensions of its profiles and frames.

In terms of thermal insulation, **MB-59HS** profiles have two different variants: ST and HI. The range of available profiles include 2- and 3-rail frames, and leaves that are adapted to two heights of rolling devices. A wide range of glazing enables the use of double and triple glazing units, including safety and sound insulation units. Due to its characteristics, the **MB-59HS** can be used in various types of buildings: individual buildings, hotels or apartments.

wide range of solutions

optimal constructions



Convenient exit to the terrace

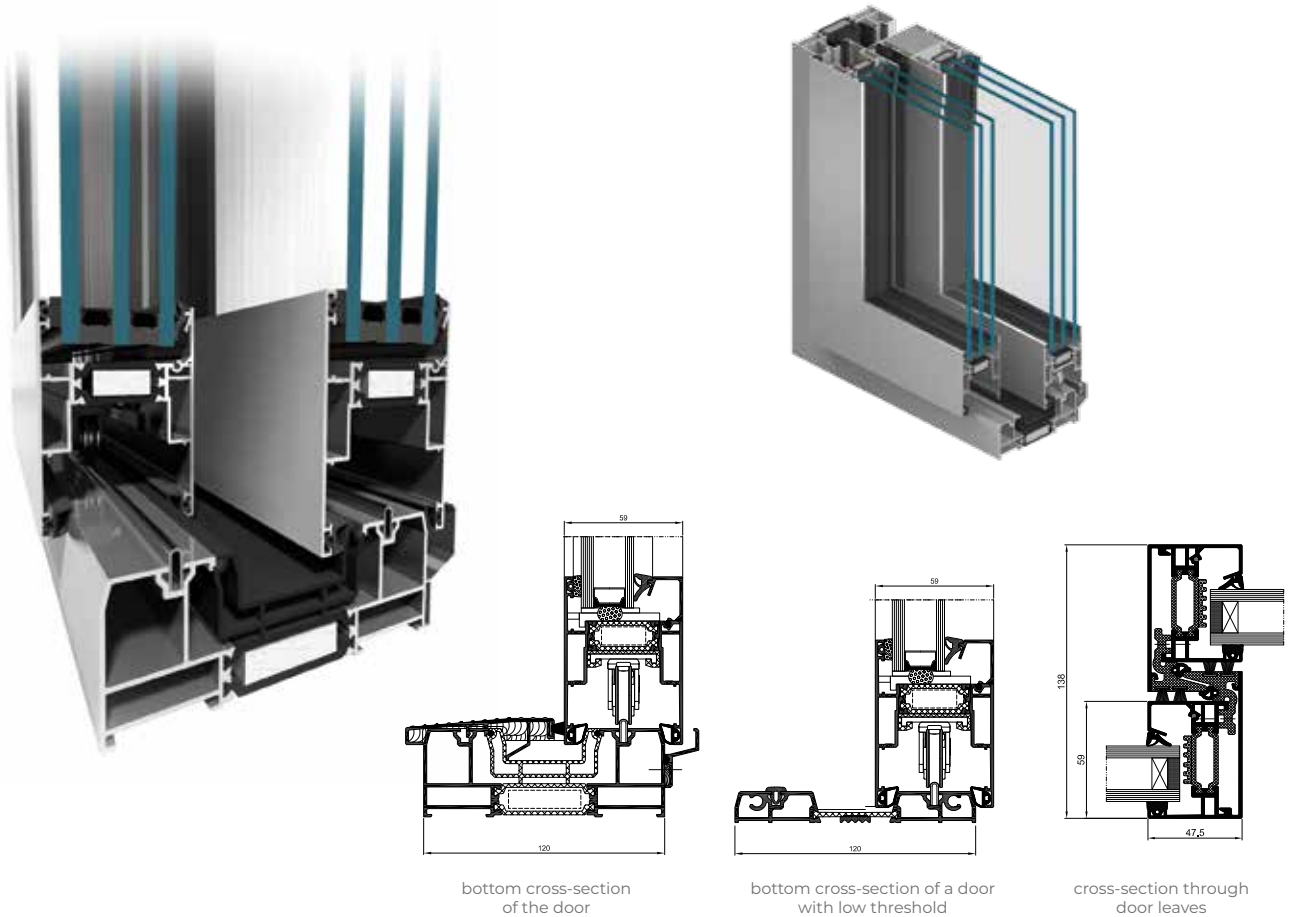

bottom cross-section  
of the door

bottom cross-section of a door  
with low threshold

cross-section through  
door leaves

## FEATURES AND BENEFITS

- important dimensions of the door leaves that exceed by far any standard values: height up to 2.8 m, width up to 3.3 m; and max. leaf weight up to 300 kg
- slender and robust, 3-chambered profiles, with insulating chamber equipped with wide thermal breaks in the central part
- 2-or 3-rail frames that enable the fabrication of doors with wide clear passage size
- the slender mullion is forty-seven millimetres wide
- large glass thickness to be fitted in the door leaves (up to 42 mm) to bring flexibility in choosing the appropriate glass
- fixed lites can be fabricated with glass mounted directly to the frame – a solution that is both aesthetic and economical
- relatively low heat transfer coefficient for frames ( $U_f$ ) assured by wide thermal breaks, polyethylene inserts and chambered profiles mounted in thermal insulation strips
- high water and air tightness assured by specially-shaped gaskets and hardware that allow the leaf to embed on the frame in the final stage of closing the leaf
- ability to mount most of the hardware for lift & slide doors available on the market
- door version with a low-level threshold, which makes it easier to use the door especially by the elderly or disabled
- doors can be mounted individually or as part of larger constructions : mullion and transom curtain walls or winter gardens
- maximally simplified construction technology to reduce time and costs of fabrication
- compatibility with other Aluprof systems – common components can be used

TECHNICAL SPECIFICATION	MB-59HS ST / MB-59HS HI
Frame width	120 mm (2-rail profile), 199 mm (3-rail profile)
Leaf width	59 mm
Glazing width	up to 42 mm
PROFILE WIDTH, AS SEEN FROM THE OUTSIDE	
Frame	44 mm
Leaf	83.5 – 94.5 mm
PERFORMANCE	MB-59HS ST / MB-59HS HI
Air Permeability	class 3, EN 12207
Watertightness	up to class 9A (600 Pa), EN 12208
Windload resistance	up to class C3, EN 12210



## BALCONY SLIDING DOOR SYSTEM **MB-59 SLIDE**

**MB-59 Slide** system has been designed to fabricate thermally-insulated sliding doors to be integrated in masonry walls, aluminum curtain walls, winter gardens or window walling. Sliding doors, especially large ones, can make living space visually bigger by combining it with the external terrace or garden. In terms of thermal insulation, MB-59 Slide profiles have two different variants: ST and HI. The range of available profiles include 2- and 3-rail frames. A wide range of glazing enables the use of double and triple glazing units, including safety and sound insulation units. The system can be used in various types of buildings: individual buildings, hotels or apartments.

short prefabrication time



Live closer to the nature

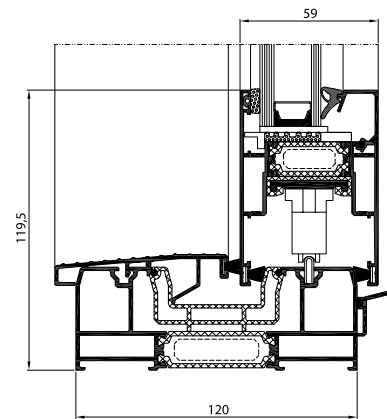
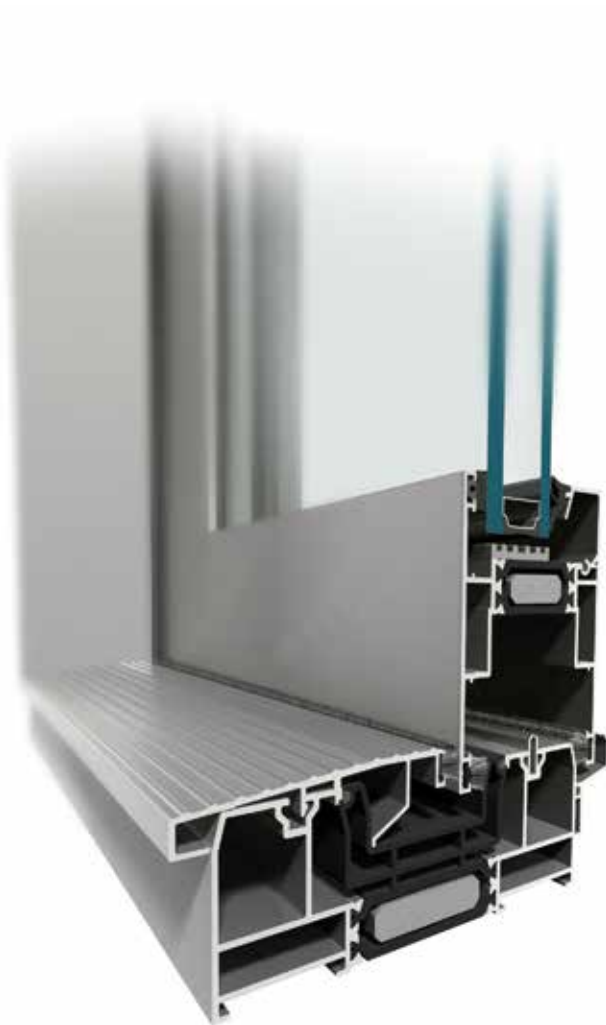

door with 2-rail frame, view

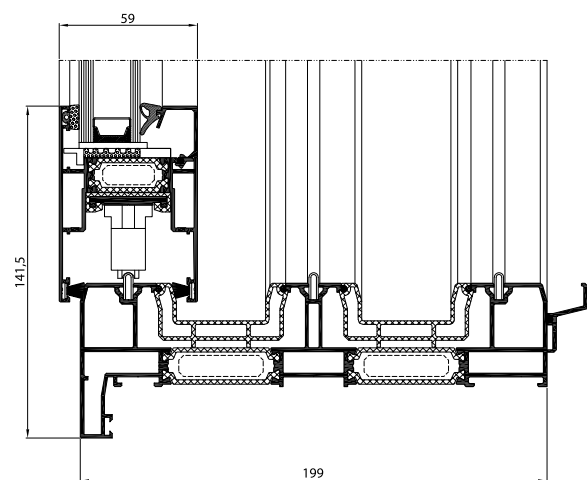

door with 3-rail frame, view

## FEATURES AND BENEFITS

- important dimensions of the door leaves: height up to 2.6 m, width up to 1.8 m; and max. leaf weight up to 160 kg
- slender and robust, 3-chambered profiles with insulating chamber equipped with wide thermal breaks in the central part
- 2-or 3-rail frames that enable the fabrication of doors with wide clear passage size
- large glass thickness to be fitted in the door leaves (up to 42 mm), to bring flexibility in choosing the appropriate glass;
- possibility to use most of the sliding door hardware available on the market
- doors can be mounted individually or as part of larger constructions: mullion and transom curtain walls or winter gardens
- maximally simplified construction technology to reduce time and cost of fabrication
- compatibility with other Aluprof systems – possibility to use common components

TECHNICAL SPECIFICATION	MB-59 SLIDE / MB-59 SLIDE HI
Frame depth	120 mm (2-rail profile), 199 mm (3-rail profile)
Leaf depth	59 mm
Glazing thickness	10.5 – 42 mm
<b>MINIMAL PROFILE WIDTH, AS SEEN FROM THE OUTSIDE</b>	
Frame	44 mm
Leaf	83.5 mm
PERFORMANCE	MB-59 SLIDE / MB-59 SLIDE HI
Air tightness	class 3, EN 12207
Water resistance	class 6A, EN 12208
Wind load resistance	class C3, EN 12210

## SLIDING FRENCH DOOR SYSTEM

# MB-59 SLIDE GALANDAGE



**MB-59 Slide Galandage** is based on the MB-59 Slide system solutions and has been designed for producing thermally insulated sliding doors that slide straight into the wall (once open, the door leaf is hidden in the wall). Installed that way, the door fully connects indoor and outdoor living spaces. **MB-59 Slide Galandage's** system profiles come in two options that offer different thermal insulation performances: ST and HI. The range of available profiles include 2- and 3-rail frames. Many glazing options allow for double and triple glazing units, including safety and sound insulation glass.

French doors that slide into the wall



Elegant connection of indoor and outdoor living spaces



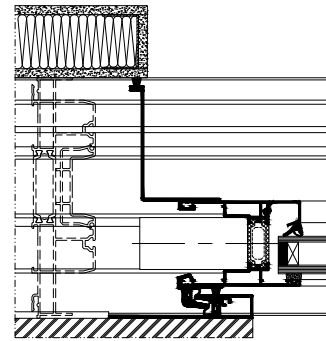

doors with 2-rail frame built into the wall,  
side view

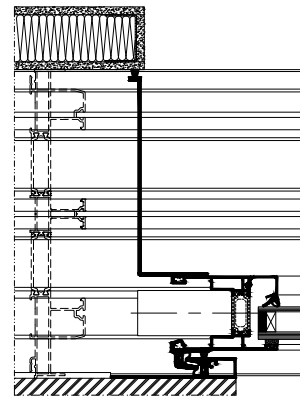

doors with 3-rail frame built into the wall,  
side view

## FEATURES AND BENEFITS

- door leaf hidden in the wall gives full access to the open space of the terrace or garden,
- large size of door leaves: up to 2.6 m high, up to 1.8 m wide and up to 160 kg in weight
- slender and robust 3-chambered profiles with a thermally broken central chamber,
- 2-or 3-rail frames to produce doors with wide clear passage size
- large glazing options (up to 42 mm) to bring flexibility in choosing the appropriate glass
- can use most of the sliding hardware available on the market

TECHNICAL SPECIFICATIONS	MB-59 SLIDE GALANDAGE / MB-59 SLIDE GALANDAGE HI
Frame depth	166.9 mm (2-rail profile), 245.9 mm (3-rail profile)
Leaf depth	59 mm
Glazing thickness	10 – 42 mm
<b>MINIMAL PROFILE WIDTH, AS SEEN FROM THE OUTSIDE</b>	
Frame	44 mm
Leaf	83.5 mm

PERFORMANCE	MB-59 SLIDE GALANDAGE / MB-59 SLIDE GALANDAGE HI
Air tightness	class 3, EN 12207:2001
Water resistance	class 5A, EN 12208:2001
Wind load resistance	class C2/B2, EN 12210:2016



## FIRE RATED WALLS SYSTEMS

# MB-78EI MB-78EI DPA MB-118EI

Fire-rated partition walling system **MB-78EI** is used for fabrication of internal or external fire partitions with single and double doors classified fire-resistant EI15, EI30, EI45 or EI60 to EN 13501-2+A1:2010. If needed, fire doors can simultaneously have smoke leakage characteristics. **MB-78EI** enables fabrication of automatic sliding doors – **MB-78EI DPA** classified fire-resistant EI15 or EI30. The **MB-118EI** system is based on **MB-78EI**, and is used to fabricate EI120-fire rated structures. Fire doors can be integrated in fire-resistant curtain walls MB-SR50N EI and MB-SR50N EI EFEKT.

fire resistance up to EI 120



Gain valuable time

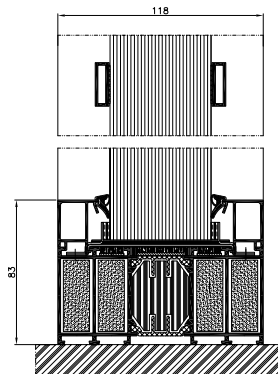
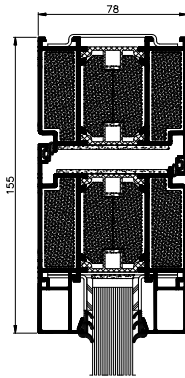
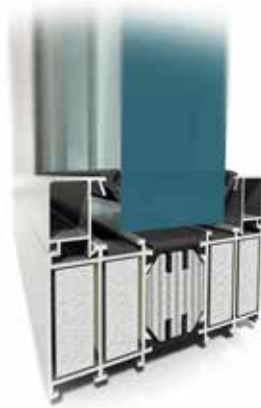
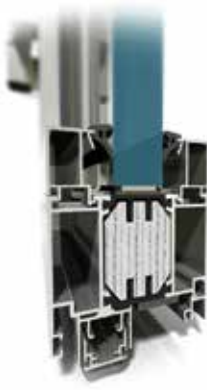

**MB-78EI DPA**

Automatic sliding fire doors

The MB-78EI DPA system is used for internal or external fire barriers with automatic sliding single- or double-leaf doors in the class EI15 or EI30. The applied motor allows the efficient and failure-free operation of doors with a leaf weight of up to 200 kg.

The maximum size of the structure in a door opening:

- height of 1-leaf and 2-leaf doors: up to 2515 mm
- width of 1-leaf doors: up to 1155 mm
- width of 2-leaf doors: up to 2326 mm

**FEATURES AND BENEFITS**

- single or double-acting doors with leaf up to H=3000 mm or automatic sliding doors MB-78EI DPA up to H=2515 mm
- fixed walls and partitions with doors up to 4 m high
- possibility to use oblique battens, to bend, and to create arch structures
- wide selection of accessories, including aesthetically looking roller guides



TECHNICAL SPECIFICATION	MB-78EI	MB-118EI
<b>PROFILES DIMENSIONS</b>		
Frame width	78 mm	118 mm
Leaf width	78 mm	—
Glazing width	6 – 49 mm	31 – 84 mm
<b>MIN VISIBLE WIDTH T PROFILE</b>		
Door frame	51 (72) mm	83 mm
Door leaf	72 (51) mm	110 mm
<b>SIZE AND WEIGHT LIMITATIONS</b>		
Max. size of door leaf / curtain wall element (H×W)	H to 3000 mm, W to 1400 mm	H to 2500 mm, W to 1400 mm
Max. weight of door leaf / curtain wall	250 kg	410 kg

PERFORMANCE	MB-78EI	MB-118EI
Air Permeability	class 2, EN 12207	class 4, EN 12207
Watertightness	class 5A, EN 12208	class RE750, EN 12208
Fire resistance	partition walls & rebated doors: EI15, EI30, EI45, EI60, EI 90, EN 13501-2, automatic sliding doors: EI30, EN 1634-1	EI120, EN 13501-2
Thermal insulation	U <sub>D</sub> from 1.0 W/(m²K)*	—
Acoustic Insulation	R <sub>w</sub> to 41 dB	—

\* - for door MB-78EI (EI30) leaf 1462×2817 mm, infilled with triple glazing units U<sub>g</sub>= 0.5 W/(m²K)



## SILICONE JOINTED GLAZED WALLS **MB-78EI**

Aluprof offers **MB-78EI** system-based transparent fire-rated wall solution – "Silicone jointed fire-rated glazed walls". This enables fabrication of internal partitions walls without the visible vertical wall profiles that separate the individual modules of the wall, while preserving its full fire resistance. The joint between the glass panes is only 4 mm and is filled with firestop, intumescent material and with non-inflammable silicone. The silicone is available in three colours (black, grey or white). Partition walls can thus have a height of more than 3.6 m with modules' width up to 1.8 m. Fire tests performed by the Poland's Building Research Institute (ITB) on these partition walls included the so-called "free-edge model", so there is no limit on the maximum length of this type of walls.

**MB-78EI** brings virtually unlimited design and construction possibilities of very large internal partition walling. Thanks to the transparent modules, all the constructions fabricated using this system make the interiors optically bigger. The system also provides security by allowing the arrangement of the building's fire zones and this ensuring appropriate conditions for the evacuation of building occupants.

fire resistance up to EI 60



Fire protection of office space

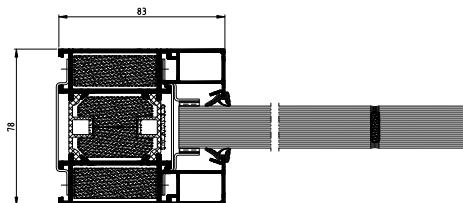

silicone jointed glazed walls – cross section EI60

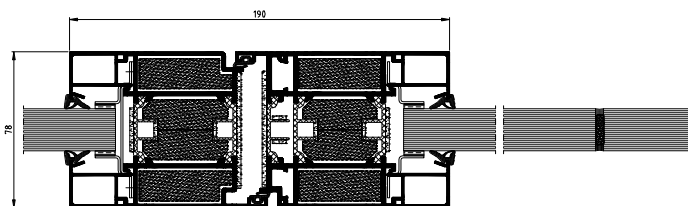

door – cross section EI30

### MB-78EI SELECTED CONFIGURATIONS

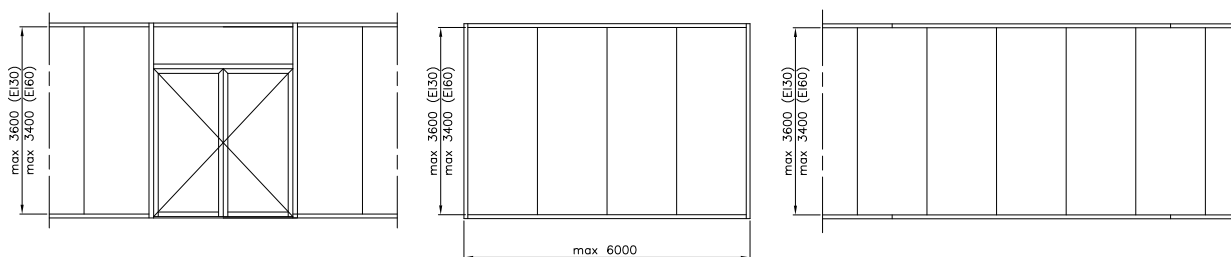
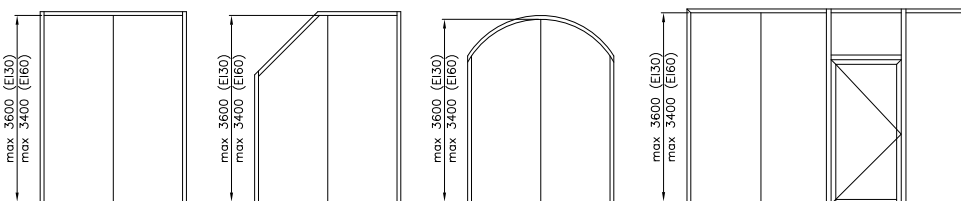

### FEATURES AND BENEFITS

- our solution has been designed and then tested at the ITB in two fire-rating classes: EI30 and EI60
- joint width between the modules is only 4 mm
- max. width of a single module is 1.5 m (max. height is 3.6 m) or 1.8 m (max. height is 3.0 m)
- unlimited width of single walls





## FIRE WINDOW AND DOOR SYSTEM **MB-86EI**

**MB-86EI** is used for fabrication of EI30 fire-rated openable windows, walls and doors compliant with EN 13501-2+A1. **MB-86EI** is based on MB-86 system, and has excellent thermal, sound reduction, water resistance and air permeability performances. The **MB-86EI** combines the advantages of a classic window and door system with the properties of a fire screen – the construction meets all the requirements of the applicable regulations and standards, especially regarding energy saving and environmental protection, while ensuring proper fire safety. The system is classified as non-fire spreading (NRO).

fire resistance up to EI 30



Energy-efficient window and door with EI30 fire rating

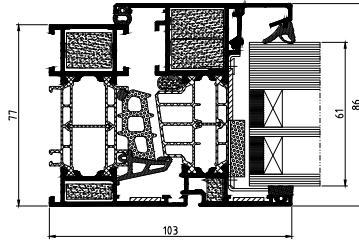
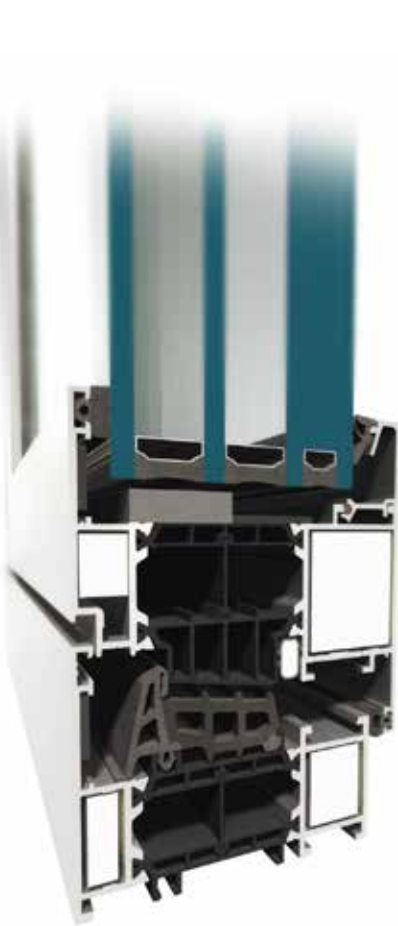

MB-86EI opening window – cross-section

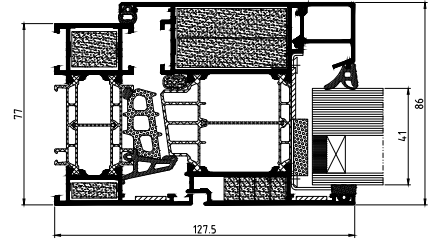

MB-86EI opening window – cross-section

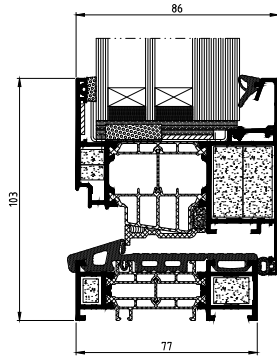

bottom cross-section of a door with low threshold

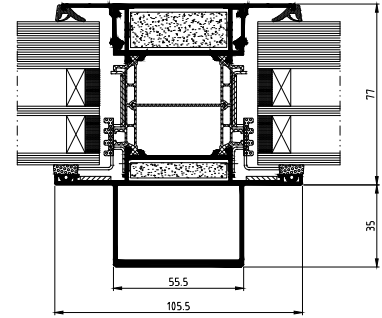

cross-section through wall with triple glazing

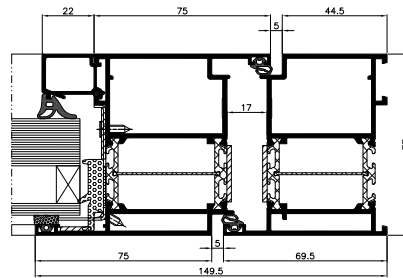

door – cross section EI30

## SYSTEM CHARACTERISTICS

- three-chambered profiles, with a 43 or 42 mm-wide insulation chamber between thermal breaks as a central part
- fire resistance is ensured by the appropriately rated glass panes, fire insulation elements in the internal chambers of aluminium profiles and special accessories and materials used in the space between aluminium profiles and the glazing
- wide range of glazing thickness allows for use of different types of insulated glass, including triple glazing units
- fixed walls and partitions with doors (EI 15 and EI 30)
- the elimination of the need for internal insulation inserts means that the MB-86 EI ≥ 30 can be built with optimal speed
- hardware used in MB-86EI is typically RC2 burglar-resistant-rated



TECHNICAL SPECIFICATION	WINDOWS MB-86EI	DOOR MB-86EI
Frame depth	77 mm	77 mm
Casement depth	86 mm	77 mm
Glazing thickness	frame: 41 – 61 mm, casement: 41 – 70 mm	41 – 61 mm
MAX. SIZE OF THE CONSTRUCTION		
Max. casement size (H×W)	H to 2400 mm, W to 1600 mm	H to 3000 mm, W to 1300 mm
TECHNICAL PARAMETERS	WINDOWS MB-86EI	DOOR MB-86EI
Air Permeability	class 4, EN 12207	class 4, EN 12207
Watertightness	class E 1500, EN 12208	class E 1350, EN 12208
Windload resistance	class C5, EN 12210	class C5/B5, EN 12210
Thermal insulation	$U_w$ up to 0.86 W/(m <sup>2</sup> K)*	$U_D$ up to 1.2 W/(m <sup>2</sup> K)
Fire resistance	class EI15, EI30	class EI15, EI30

\* - for a 2000×1100 mm window with triple glazing unit  $U_g=0.5$  W/(m<sup>2</sup>K) warm spacer and EI30-rated fire-resisting glazing pane



## FIRE RATED SYSTEM **MB-60E EI**

**MB-60E EI** is designed to fabricate internal or external single & double fire-rated door. This system also enables fabrication of "technical windows" and fire-rated partition walls.

Constructions fabricated based on **MB-60E EI** can be classified fire-resistant EI 15 and EI 30 to EN 13501-2+A1:2010 and non-fire spreading (NRO).

fire resistance up to EI 30



Strength & Safety



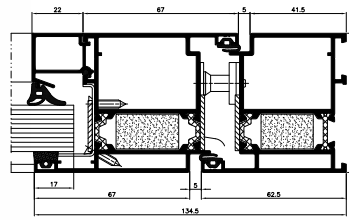

EI30 door – view

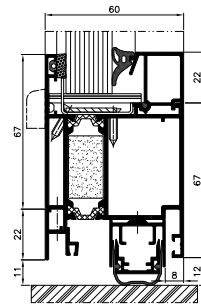

EI30 door – view

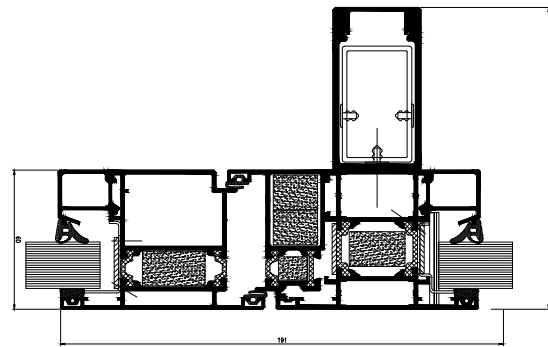

cross-section through a partition as specified in ETA

## FEATURES AND BENEFITS

- MB-60E-based, it enables the use of elements that are common to both systems
- product scope: single & double door with side lite, plus walls.
- constructions classified EI15, EI30
- enables the glazing of typical fire-resistant glass panes ranging from 5-41 mm
- profile design depth: 60 mm
- from-the-inside glazing with glazing strips.
- prefabrication made fast and easy

TECHNICAL SPECIFICATION	MB-60E EI
<b>PROFILES DIMENSIONS</b>	
Frame width	60 mm
Leaf width	60 mm
Glazing width	5 – 41 mm
<b>MIN VISIBLE WIDTH T PROFILE</b>	
Door frame	62,5 mm / 55 mm
Door leaf	67 mm / 76 mm
<b>SIZE AND WEIGHT LIMITATIONS</b>	
Max. size of door leaf / wall area (H×W)	H up to 2475 mm, W up to 1400 mm
Max. weight of door leaf / wall area	120 kg
<b>TYPES OF CONSTRUCTION</b>	
Solutions	outward-opening, single-leaf, double-leaf and partition doors

PERFORMANCE	MB-60E EI
Air Permeability	class 2
Watertightness	class 3A, EN1027, EN12208
Windload resistance	C5, EN 12211; EN 12210
Fire resistance	partition walls & rebated doors: EI15, EI30; EN 13501-2+A1



## FIRE-RESISTANT GLASS **GLASSPROF EI**

**GLASSPROF's EI-rated glass**, which is manufactured by GLASSPROF sp. z o.o., a subsidiary of ALUPROF SA., is designed for use in building structures such as windows, doors, partitions, façades and similar. The company's product range includes not only EI 30, EI 60 and EI 90 fire-rated glass, but also other types of glazing. The technology used at GLASSPROF enables us to produce insulating glass units featuring a range of glass functions, including fire resistance, thermal insulation, sun protection, sound reduction and security. Our EI glass is layered in structure, made with sheets of 5-mm-thick, clear, tempered glass to ensure user safety and reduce the risk of breakage during transport, installation and use. The panes are separated by a layer of special fire-resistant gel. The overall thickness of glass constructed in this way ranges from 15 mm for EI 30 glass to 35 mm for EI 90 glass. The fire rating determines the quantity of tempered glass and layers of gel. The gel used in GLASSPROF panes is resistant to radiation. As a result, it crystallises in the event of fire, forming a layer that provides fire insulation and safety. The fundamental advantages of **GLASSPROF EI** glazing are its high transparency, low weight and UV resistance.

fire resistance up to EI 90



Safety glass



Glassprof EI30



Glassprof EI60



Glassprof EI90

### Functions and aesthetics of GLASSPROF fire-resistant glass:

- it is neutral in colour and features a transparency level (Lt) as high as 87%
- the radiation resistance has been confirmed by independent testing
- it has been awarded a safety class 1B1 classification, the highest as per the EN 12600 standard
- a high level of sound reduction reduces noise by 93% and more
- it is lightweight, at 32.5 kilograms for our EI30 glass
- large-scale glazing is possible
- GLASSPROF's glass components are produced with tempered glass featuring automatically smoothed edges
- there is no need to use external laminated glass to protect the fire-resistant glass in insulating units from UV radiation
- no aluminium tape is needed on the edges of the glass for moisture protection
- the production technology is state-of-the-art and fully automated
- the glass is also available in the form of single- and double-glazing units featuring a range of glass functions



Fire proof



Tempered glass



Lightweight

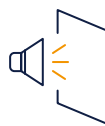

Reduces noise



Impact resistant



Transmits light



Large dimensions



High temperature range

TECHNICAL SPECIFICATION	GLASSPROF EI30	GLASSPROF EI60	GLASSPROF EI90
FIRE RESISTANCE (EN 13501-2)	EI 30	EI 60	EI 90
Thickness	15 mm	25 mm	35 mm
Composition	5 / 5 / 5	5 / 5 / 5 / 5 / 5	5 / 5 / 5 / 5 / 5 / 5 / 5
Weight	32.5 kg/m <sup>2</sup>	52.5 kg/m <sup>2</sup>	72.5 kg/m <sup>2</sup>
Temperature range for transport, storage and use	-10 / +45°C		
Visible light transmission Lt (EN 410)	87 %	84 %	82 %
Solar factor g (EN410)	74 %	69 %	66 %
U <sub>g</sub> value (EN 673)	5.0 W/m <sup>2</sup> K	4.5 W/m <sup>2</sup> K	4.0 W/m <sup>2</sup> K
Sound reduction R <sub>w</sub> (C; Ctr) (EN ISO 10140-2, EN 717-1)	39 (-1; -2) dB	43 (-2; -2) dB	45 (-2; -3) dB
Radiation resistance (EN 12543-4)	2000 h		
Humidity resistance (EN 12543-4)	2 weeks / 100% relative humidity		
Pendulum impact class (EN 12600)	1B1		
Hazardous substances	none		



## DOOR AND WINDOW SYSTEMS

# **MB-60** **MB-60US** **MB-60 PIVOT** **MB-60EF**

The **MB-60** is a stable, universal and complete window and door system for any application requiring enhanced thermal performance that reflect different needs of the various market segments. Its wide selection of compatible components enables to construct various elements from basic thermally insulated windows and doors to pivot and concealed sash windows, industrial type windows with the steel like lookout and security doors. Majority of system varieties are available in both standard and HI version with increased thermal insulation properties.

great number of solutions' options



**INSTYTUT TECHNOLOGII ŻYWNOŚCI I GASTRONOMII PWSIP**  
Location: Łomża / Poland / Design: PW ARKON

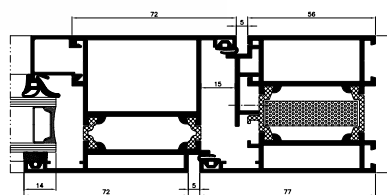
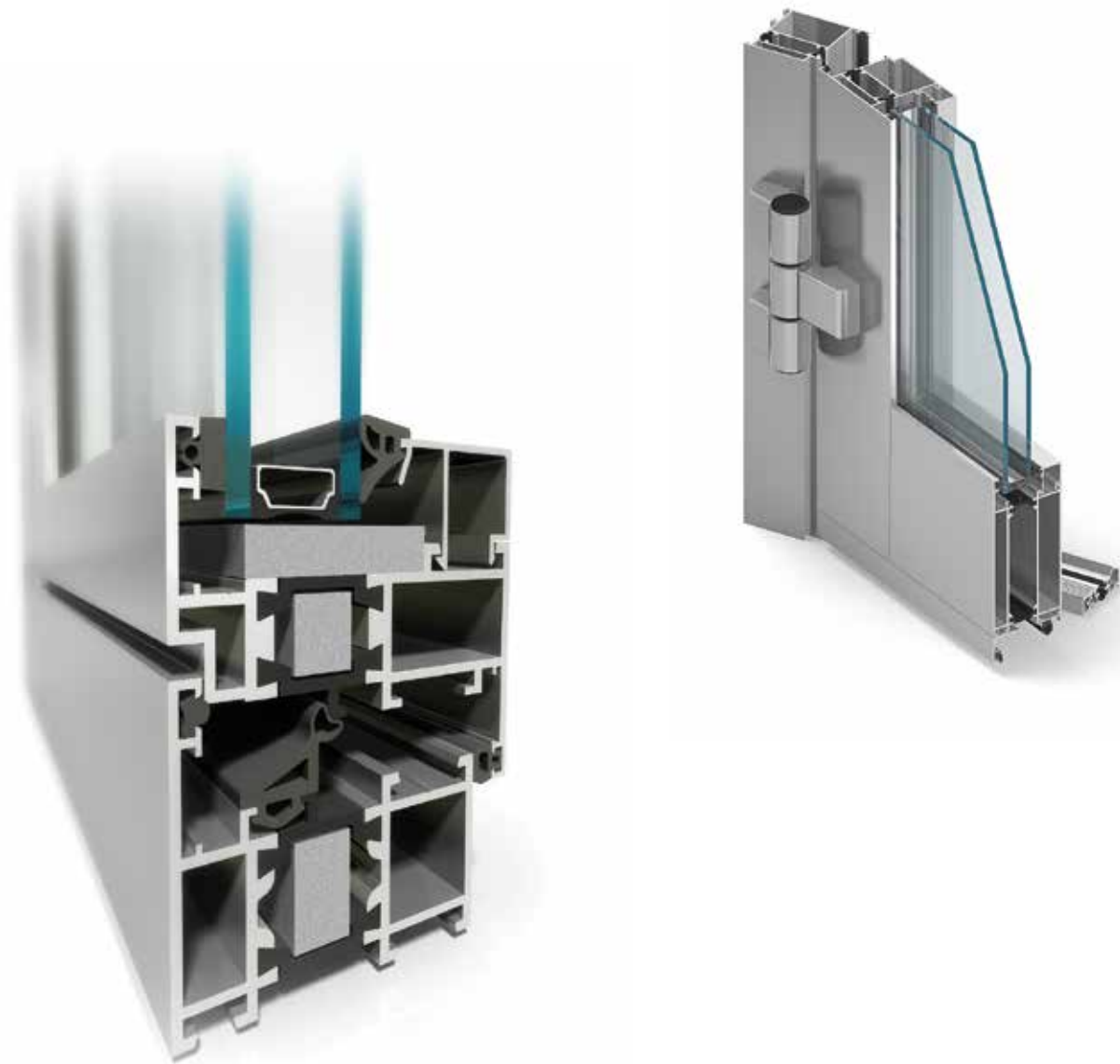

door – cross-section

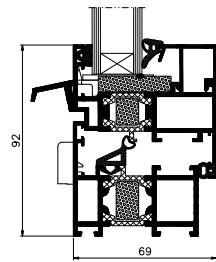

window – cross-section

## FEATURES AND BENEFITS

- a range of functions and methods of opening, adapted to the users' needs
- a range of aesthetic solutions offered by windows with concealed casements, including the 'steel look' Industrial version
- three types of glazing beads are available: Standard, Prestige and Style
- outward- and inward-opening, single-leaf, double-leaf doors; large-scale structures are also available
- the profiles can be bent, and arched windows can be built
- structures built using the system can be installed in single-family homes and façades
- aesthetic connection with façades
- burglary resistant windows and doors
- two-colour structures can be built, with one colour on the outside and another on the inside
- the use of the CE marking is possible

## MB-60US MB-60US HI

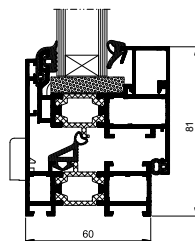

opening window – cross-section

The invisible sash system variety enables to accomplish an effect of indifferent look of series of neighboring combination of fixed and opening windows from the outside of the building. It is presented in regular and enhanced thermal performance varieties.

## MB-60E MB-60E HI

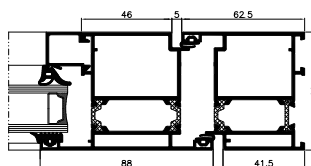

door – cross-section

The extremely cost efficient system for making thermally insulated doors and sets of windows and doors. It offers combination of good performance and limited production costs related to shorter time and high ease to manufacture.

## MB-60 PIVOT

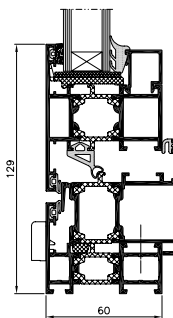

pivot window – cross-section

The pivot variety is available for both vertical pivot and horizontal pivot applications ensuring flexibility. Its hardware enables for window to open a full 180 degrees. The key competitive advantages it offers include large size and weight limitations.

## MB-60EF MB-60EF HI

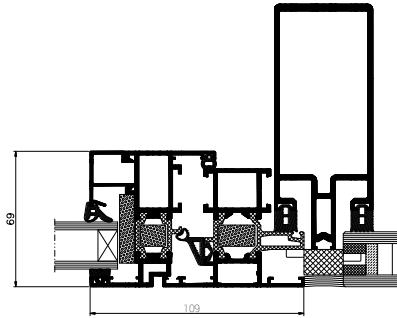

active window in a curtain wall – cross-section

The system variety features windows integrated with the MB-SR50 EFEKT curtain wall partitions, therefore enables for specific visual effect – on the “all-glass” external surface of the curtain wall there comes a clear outline of an aluminum window frame. External surfaces of window profiles and glass panels are aligned. It is presented in regular and enhanced thermal performance varieties.

TECHNICAL SPECIFICATION	MB-60 MB-60 HI	MB-60US MB-60US HI	MB-PIVOT	MB-60E MB-60E HI	MB-60EF MB-60EF HI
<b>PROFILES DIMENTIONS, A RANGE OF GLAZING</b>					
Depth of frame (door / window)	60 mm / 60 mm	60 mm			
Depth of leaf (door / window)	60 mm / 69 mm	69 mm		60 mm	69 mm
Glazing range (fixed window and door / opening window)	5 – 44 mm / 14 – 52 mm	4 – 35 mm / 8 – 44 mm	5 – 41 mm / 14 – 50 mm	5 – 41 mm	—
<b>MIN VISIBLE WIDTH T PROFILE</b>					
Door / window frame	51 mm / 47 mm	75 mm	47 mm	41,5 mm	72 mm
Door / window leaf	72 mm / 29 mm	34,6 mm	76 mm	67 mm	72 mm
<b>SIZE AND WEIGHT LIMITATIONS</b>					
Max. size of window (H×W)	H to 2400 mm W to 1250 mm	H to 1900 mm W to 1100 mm	H to 2000 mm W to 2400 mm	—	H to 2400 mm W to 1250 mm
Max. size of door (H×W)	H to 2400 mm W to 1200 mm	—	—	H to 2300 mm W to 1300 mm	—
Max. weight (doors / windows)	120 / 130 kg	130 kg	180 kg	120 kg	130 kg
<b>TYPES OF CONSTRUCTIONS</b>					
Solutions	Tilt windows, turn windows, tilt&turn windows, tilt sliding windows and doors, doors open in and open out	Fixed windows, tilt windows, turn windows, tilt&turn windows	Pivot windows	Doors and window and door sets	Tilt&turn windows in curtain walls
<b>PERFORMANCE</b>					
Air Permeability	class 4			class 3	class 4
Watertightness	class E900 EN 1027; EN 12208			class E1200 EN 1027; EN 12208	
Windload resistance	C5 EN 12211; EN 12210		class C2 EN 12211; EN 12210	class C1 EN 12211; EN 12210	class C4 EN 12211; EN 12210
Impact resistance	class 3	—	—	class 3	—



## WINDOW AND DOOR SYSTEM

# **MB-59S** **MB-59S CASEMENT** **MB-59S SE** **MB-59S PIVOT**

The **MB-59S** is designed for creating external architectural elements where extremely good thermal and acoustic insulation parameters are required. It is used for a wide range of windows, doors, vestibules, shop windows and so forth. In addition to standard windows and doors, the **MB-59S** provides a basis for structures like the MB-59S CASEMENT outward-opening window, the MB-59S Pivot window and our MB-59SE economical door. Most of these solutions are available in the HI version, which features increased thermal insulation.

economical and functional



**MALTA OFFICE PARK**

Location: Poznań / Poland / Design: Architects Litoborski + Marciniak



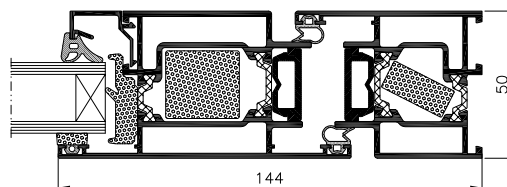
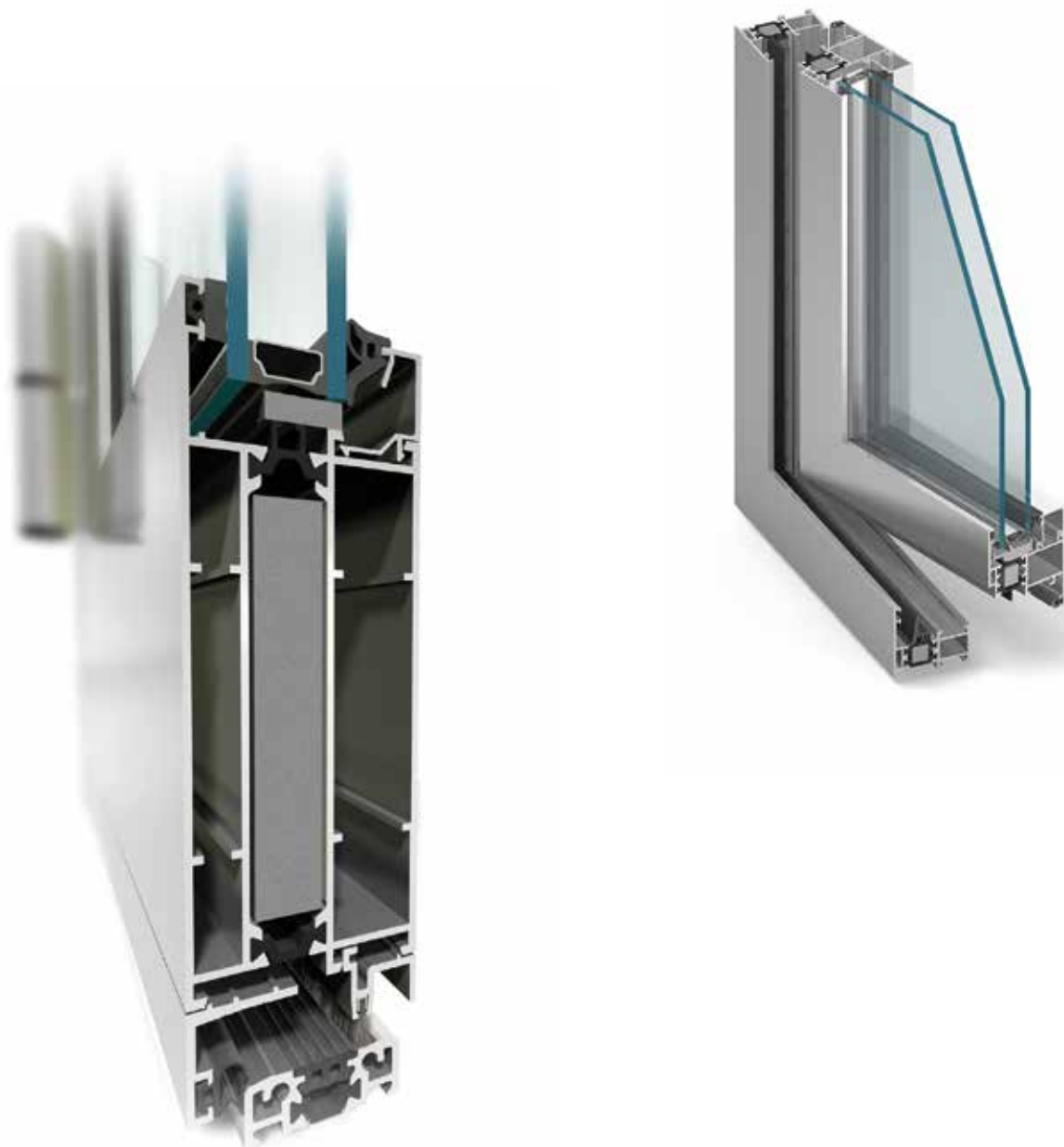

door – cross-section

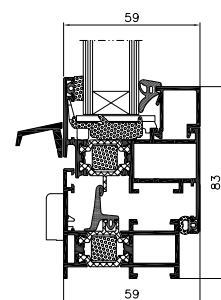

opening window – cross-section

## FEATURES AND BENEFITS

- a range of functions and window opening methods
- outward-opening, inward-opening and manually or automatically operated single-leaf, and double-leaf doors are available
- the doors are designed to enable the use of a range of hardware, including rebate hinges
- three types of glazing beads are available: Standard, Prestige and Style
- the profiles can be bent, and arched windows can be built
- two-colour structures can be built, with one colour on the outside and another on the inside
- structures built using the system can be installed in single-family homes and façades
- the use of the CE marking is possible

## MB-59S MB-59S HI

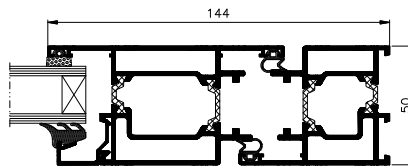

door – cross-section

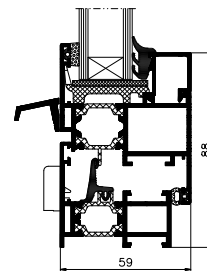

opening window – cross-section

The basic version of the MB-59S system is used to build different types of windows, doors and shop-window units. It is a universal solution. The profiles are three-cavity structures, and they are designed to enable the use of a range of window and door hardware. The MB-59S HI features inserts which increase the thermal insulation parameters of the structure.

## MB-59S CASEMENT MB-59S CASEMENT HI

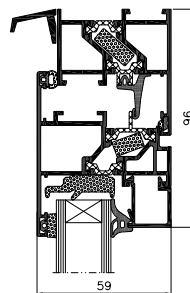

outward opening window – cross-section

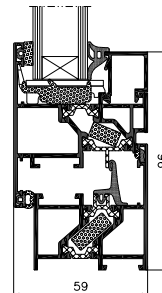

The MB-59S CASEMENT is used to produce tilt and outward-opening windows. They can be fitted with pivot or scissor hinges. This system also makes it possible to produce the MB-DPA automatic and manual sliding door.

## MB-59SE

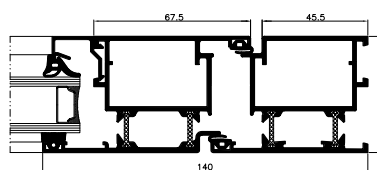

door – cross-section

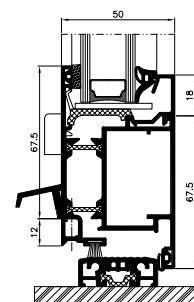

cross-section of the bottom rail in door

This modern variety is designed for economy type of doors and combination of doors and windows that meet enhanced performance requirements.



# MB-59S PIVOT MB-59S PIVOT HI

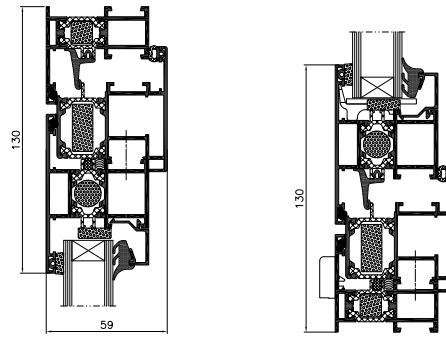

pivot window – cross-section

The pivot window is available in horizontal or vertical applications which makes it an appropriate window for most occasions. The compliance with safety and ventilation requirements makes the pivot the ideal choice for hospitals, schools and offices. It is greatly compatible with curtain wall systems for enabling easy and intuitive assembly to already set wall.

TECHNICAL SPECIFICATION	MB-59S MB-59S HI	MB-59SE	MB-59S CASEMENT MB-59S CASEMENT HI	MB-59S PIVOT MB-59S PIVOT HI
<b>PROFILES DIMENTIONS, A RANGE OF GLAZING</b>				
Depth of frame (door / window)	50 mm / 50 mm	50 mm	50 mm	50 mm
Depth of leaf (door / window)	50 mm / 59 mm	50 mm	59 mm	59 mm
Glazing range (fixed window and door / opening window)	4.5 – 31.5 mm / 4.5 – 40.5 mm	4.5 – 31.5 mm	4.5 – 31.5 mm / 4.5 – 40.5 mm	4.5 – 31.5 mm
<b>MIN VISIBLE WIDTH T-PROFILE</b>				
Door / window frame	36.5 mm / 47.5 mm	45.5 mm	33.5 mm	47.5 mm
Door / window leaf	72.5 mm / 34.5 mm	67.5 mm	72.5 mm	77.5 mm
<b>SIZE AND WEIGHT LIMITATIONS</b>				
Max. size of window (H×W)	H to 2400 mm W to 1250 mm	—	H to 2000 mm W to 2400 mm	
Max. size of door (H×W)	H to 2300 mm W to 1100 mm	H to 2300 mm W to 1000 mm	—	—
Max. weight (doors / windows)	100 / 130 kg	100 kg		180 kg
<b>TYPES OF CONSTRUCTIONS</b>				
Solutions	Titl window, turn window, tilt&turn window, doors open out and open in	Economy doors	Top or side hung window	Pivot window with horizontal or vertical applications
<b>PERFORMANCE</b>				
Air Permeability	class 4 EN 1026; EN 12207	class 2 EN 1026; EN 12207	class 4 EN 1026; EN 12207	
Watertightness	E1050 EN 1027; EN 12208	3A EN 1027; EN 12208	E1050 EN 1027; EN 12208	AE750 EN 1027; EN 12208
Windload resistance	C3 EN 12211; EN 12210	C2 EN 12211; EN 12210	C5 EN 12211; EN 12210	CE2400 EN 12210
Impact resistance	class 3	class 4	class 1	—



## INTERIOR GLASS PARTITIONS **MB-HARMONY**

The **MB-HARMONY** is a single-glazed system which is part of the MB-HARMONY OFFICE glass partition series. Its assembly is geometrically easy and does not require special construction tools. It is designed to be combined with tempered glass and 10-12 mm acoustic glass. The system is ideal for typical office spaces, even those with acoustic requirements above the norms.

ALUPROF's MB-HARMONY OFFICE is a new family of products for building interior glass partitions. It was conceived in order to create an easily prefabricated and quickly installed system which will deliver a contemporary, lightweight design and user comfort in conjunction with guaranteed performance and durability.

lightweight design and user comfort



Easy and quick to install

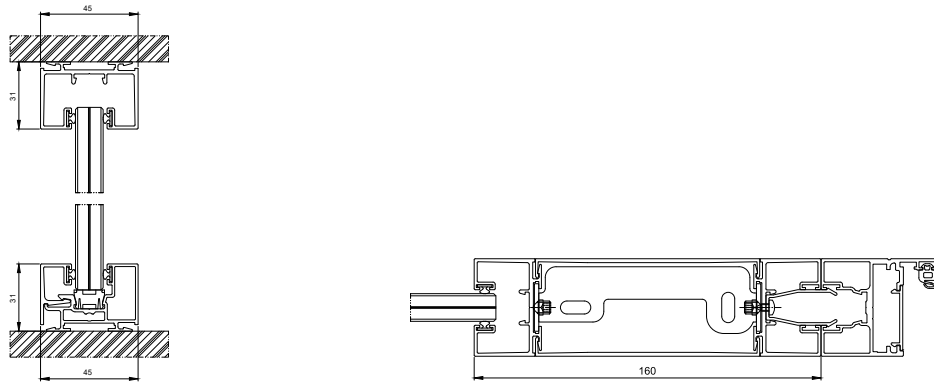

### MB-HARMONY SELECTED CONFIGURATIONS

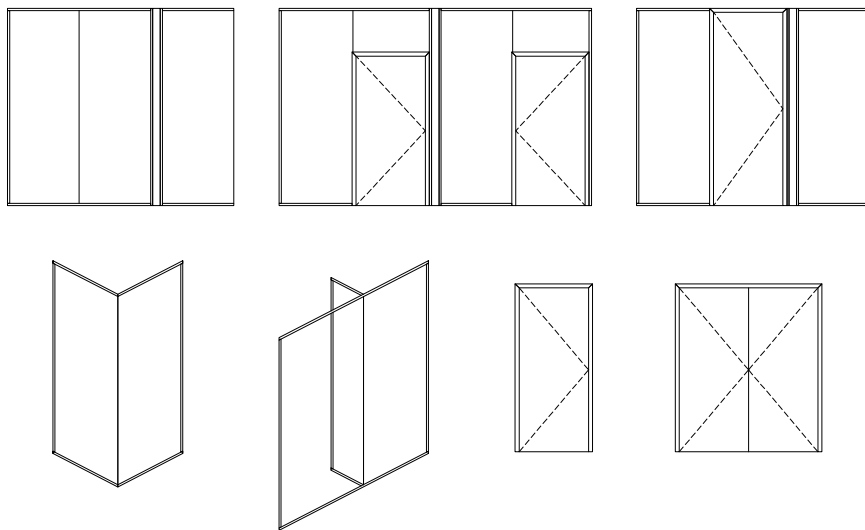

### FUNCTIONS AND AESTHETICS

- the structurally light profiles are only 31 mm in height
- the concealed glazing gaskets are inserted before the profiles are installed
- the entire system consists of just a few basic elements
- the connectors and accessories have been reduced to a minimum
- the system is simple to prefabricate, which can be done on site, and install later
- the unique installation panel is built using base profiles
- no need to use acrylic joints on adjoining walls
- hardware and accessories are mainly installed without machining, which has been limited to no more than a few instances
- the requisite machining can be carried out using portable tools
- the stability and reliability of the structure has been confirmed by tests
- frame doors with 35 and 45 mm leaves, single glazed, at a thickness of 5 to 13 mm, and double-glazed, at 25 to 35 mm
- the universal frame is suitable for all types of door
- the MB-Harmony and MB-Harmony DUO solutions are compatible

SPECIFICATIONS	MB-HARMONY
Glazing	ESG 10, ESG 12, VSG 55.1, VSG 55.2, VSG 66.1, VSG 66.2, VSG 55.2 with acoustic foil, VSG 66.2 with acoustic foil
Acoustic insulation	R <sub>w</sub> of 39 dB max. / RA <sub>1</sub> of 38 dB max.
Use category	IVb
Room category	A, B, C1+C5, D
Height	3200/3600 mm*
Finishing	anodised, RAL colours and ADEC wood and concrete colours

\* - for glass types ESG 12, VSG 66.1, VSG 66.2 and VSG 66.2 with acoustic film



## INTERIOR GLASS PARTITIONS **MB-HARMONY DUO**

The **MB-HARMONY DUO** is a system for building double-glazed interior partitions. It was designed primarily for office spaces with very high acoustic requirements. The double glazing provides the insulation essential to maintaining both excellent user comfort and the confidentiality of conversations held within its walls.

In its geometry, the DUO echoes the single-glazed partitions of its sister system, the MB-HARMONY, meaning that both solutions can be used in one architectural space, creating an aesthetic cohesion.

high acoustic parameters with an  $R_w$  of up to 48 dB



Perfect protection against noise

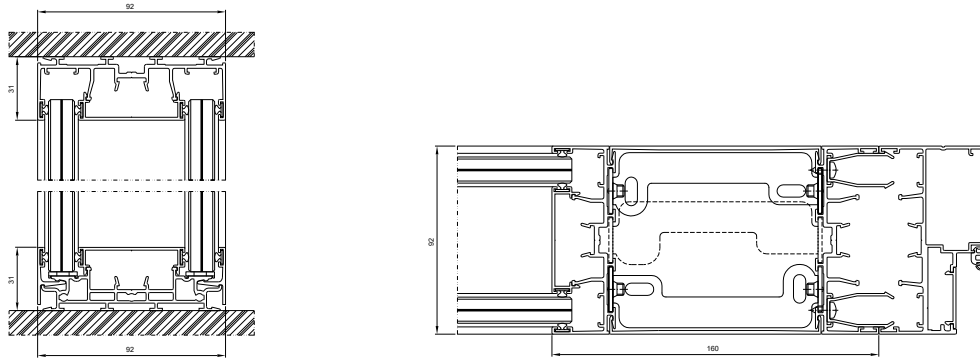

### MB-HARMONY DUO SELECTED CONFIGURATIONS

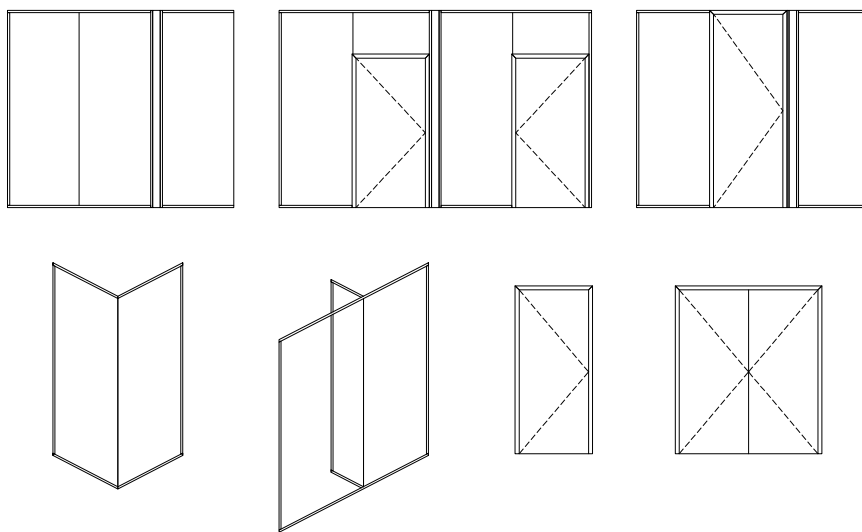

### FUNCTIONS AND AESTHETICS

- the structurally light profiles are only 31 mm in height
- the concealed glazing gaskets are inserted before the profiles are installed
- the entire system consists of just a few basic elements
- the connectors and accessories have been reduced to a minimum
- the system is simple to prefabricate, which can be done on site, and install later
- the unique installation panel is built using base profiles
- no need to use acrylic joints on adjoining walls
- hardware and accessories are mainly installed without machining, which has been limited to no more than a few instances
- the requisite machining can be carried out using portable tools
- the stability and reliability of the structure has been confirmed by tests
- frame doors with 35 and 45 mm leaves, single glazed, at a thickness of 5 to 13 mm, and double-glazed, at 25 to 35 mm
- the universal frame is suitable for all types of door
- the MB-Harmony and MB-Harmony DUO solutions are compatible

SPECIFICATIONS	MB-HARMONY DUO
Glazing	ESG 10, ESG 12, VSG 55.1, VSG 55.2, VSG 66.1, VSG 66.2, VSG 55.2 with acoustic foil, VSG 66.2 with acoustic foil
Acoustic insulation	R <sub>w</sub> of 48 dB max. / RA <sub>1</sub> of 46 dB max.
Use category	IVb
Room category	A, B, C1+C5, D
Height	3200/3600 mm*
Finishing	anodised, RAL colours and ADEC wood and concrete colours

\* - for glass types ESG 12, VSG 66.1, VSG 66.2 and VSG 66.2 with acoustic film



## PARTITION WALLING SYSTEMS

# MB-EXPO

# MB-EXPO MOBILE

The **MB-EXPO** is an elegant, glass partition walling system designed for various types of internal partition walls with all-glass doors, whose function is to separate and to soundproof the selected areas, without visually limiting the room as it is the case with the non-transparent walls.

The **MB-EXPO MOBILE** is an internal walling system that allow the fabrication of high-quality segment doors. The possibility of using the **MB-EXPO MOBILE** in high ceilings areas (up to 4m high) and of having a wide, openable door, makes it a solution oriented mainly towards shops, shopping malls, exhibition centres and office buildings.

The sections of the **MB-EXPO** and **MB-EXPO MOBILE** systems are fitted to allow installation of the hardware (locks, hinges, suspension brackets, parked systems) manufactured by Aluprof and Geze. The panes are the structural component of both systems and the glazing gaskets remain invisible, whichever the side. Both systems are offered in a variety of colours, and allow an easy fabrication & installation.

structures up to 4 m high



## Stylish Partitions



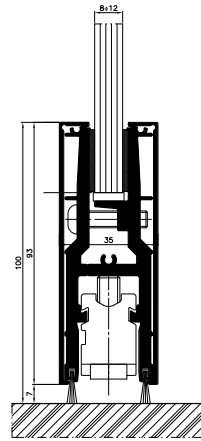

mobile and door leaf –  
lower cross-section

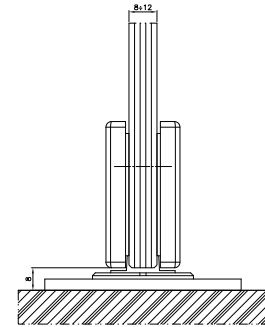

shop front –  
lower cross-section

## MB-EXPO SELECTED CONFIGURATIONS

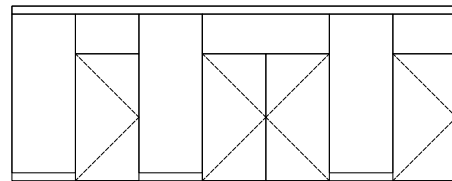
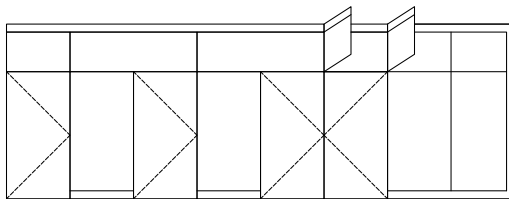
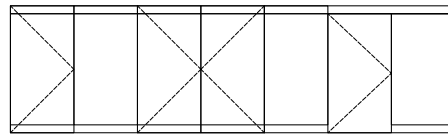
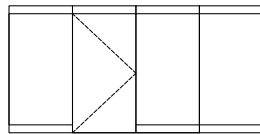

## MB-EXPO MOBILE SELECTED CONFIGURATIONS

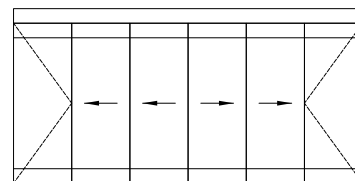
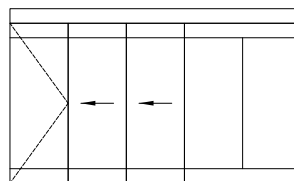
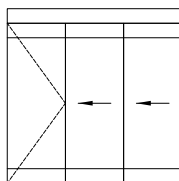

## FEATURES AND BENEFITS

- invisible glazing gaskets
- light structure
- glazing range 8-12 mm
- fixed profile depth regardless of the glass pane thickness
- structures up to 4 m high
- adapted to use numerous companies' hardware products: Aluprof, Geze



## PARTITION WALLING SYSTEM **MB-80 OFFICE**

This internal partition double-glass walling system is designed to fabricate internal partitions in offices and other public facilities.

The system enables the use of different types of infills, transparent or obscure, with internal louvers and electrical components and office equipment. These walls are especially suitable in buildings where a high sound insulation is required. The basic feature of this construction is its versatility in arranging office space, combined with the simplicity of execution of all the works on site.

The **MB-80 OFFICE** system is also available as a "silicone-jointed" version, both for straight and angled connections.

maximum construction height: 6.35 m



Practical solutions for the office

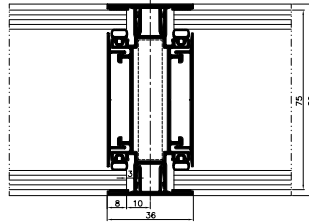

vertical section through the wall 80 mm

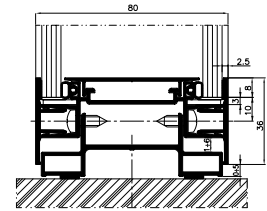

lower crossbar - view

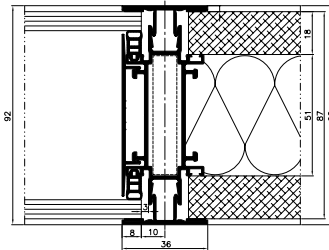

vertical section through the wall 92 mm

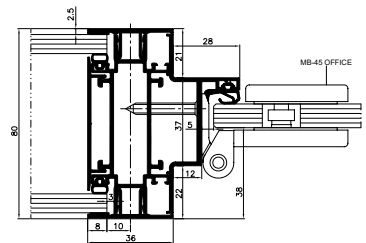

door posts - view

## MB-80 OFFICE SELECTED CONFIGURATIONS

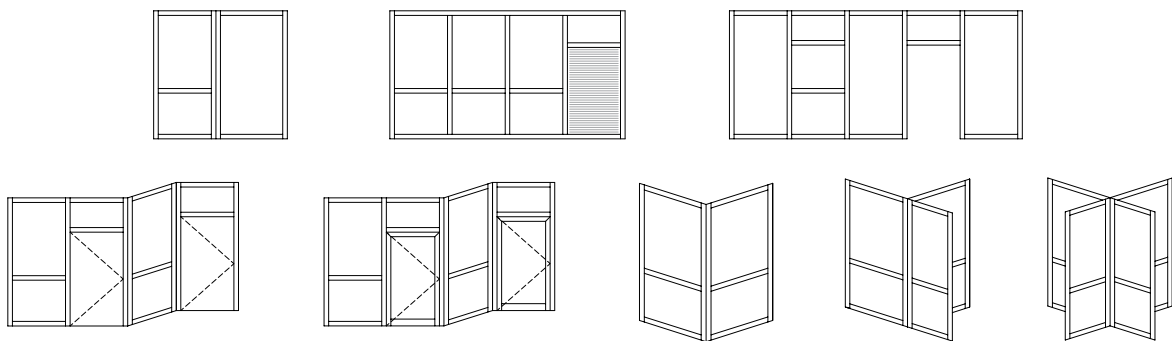

## FEATURES AND BENEFITS

- different types of infill: panes 4-14 mm thick, furniture boards 16-18 mm thick, gypsum plasterboards
- depth & construction of the basic profiles enables installation of intra-pane louvers
- can be combined with a standard, 75 mm-thick gypsum plasterboards
- excellent sound insulation in office spaces - noise reduction of 50 dB depending on the type of infill used
- possibility to fabricate 80 mm & 92 mm walls
- custom division of space, angle of refraction within the range 90°±180°
- simple prefabrication & installation, direct on-site pre-fabrication in option
- cables inside the wall, installation of standard power sockets
- can be combined with MB-45-based wall (MB-45S-based doors that flush with the plane of the wall) (flushed with the plane of the wall and with non-protruding hinges), and with MB-EXPO & MB-45 OFFICE doors (with centrally-installed leaf, flushed with the plane of the wall, plus non-protruding hinges)
- high rigidity of the profiles makes the construction fit to any interior space, for instance, a construction with 4 mm glass and 1.3 m post spacing can be up to 5.4 m high and up to 6.35 m if the posts are steel core-reinforced



## PARTITIONING SYSTEM **MB-45 OFFICE**

The **MB-45 OFFICE** fixed and door-equipped partitioning system has been designed to fabricate internal partition walls whose distinguishing feature is that a tempered glass pane can be its structural component.

Due to its versatility and wide application possibilities, the **MB-45 OFFICE** system is dedicated to the fabrication of lightweight, yet solid walls in meeting rooms and office spaces with “clearly marked” door.

The elements of this system allow to fabricate fixed partition walls and all-glass door leaves for hinged and swinging-type doors. **MB-45 OFFICE** is available in a wide range of colours – RAL and wood-like ADEC.

all-glass door made from tempered glass panel



Elegant office interior

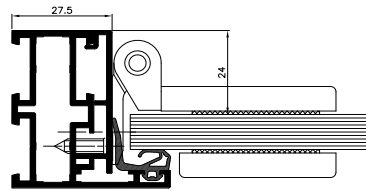

door – side view

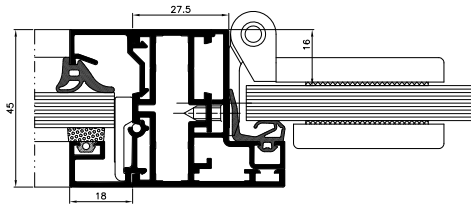

door stud – section view

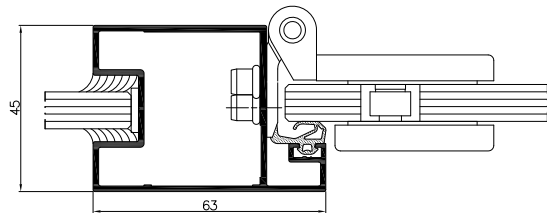

door stud and upper crossbar view

## MB-45 OFFICE SELECTED CONFIGURATIONS

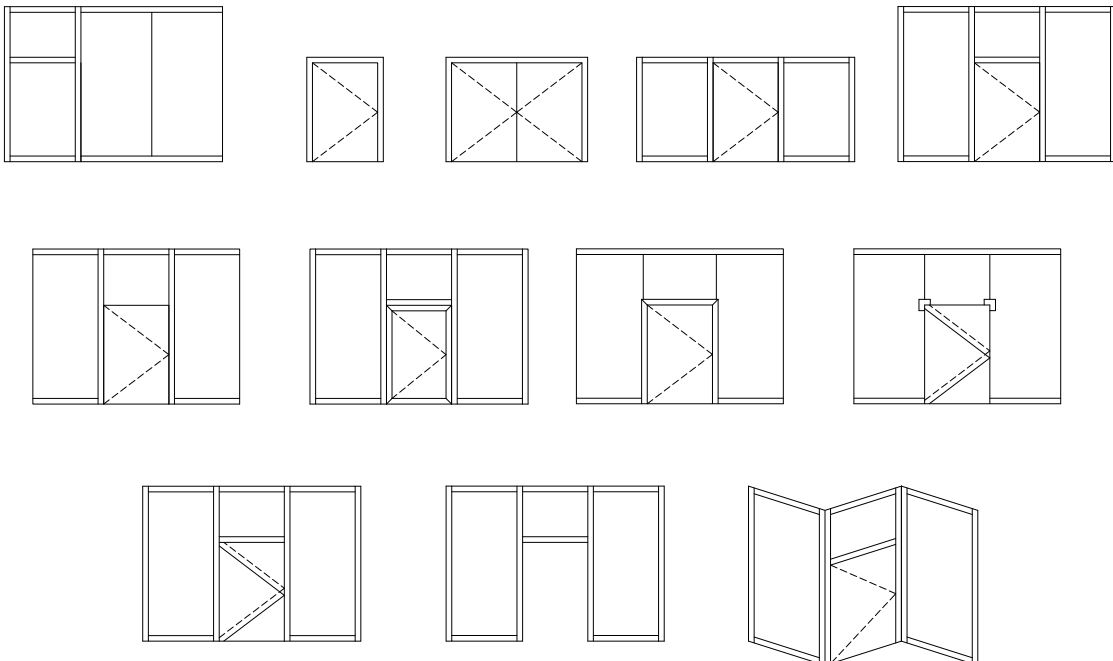

## FEATURES AND BENEFITS

- light and durable structure
- 45 mm structure depth – the system is fully compatible with the MB-45
- infill ranging from 1.5-25 mm (dedicated, 8 mm 10 mm and 12 mm tempered glass panes)
- continuous glazing gaskets, no more cutting at the corners
- possibility of changing the interior design
- adapted to use numerous companies' hardware products: Aluprof, WSS



## WINDOW AND DOOR SYSTEM **MB-45**

**MB-45** is a competitively priced non thermal window and door system. Can be used externally where no thermal insulation is required or also internally as a partition system. With its broad selection of profiles, **MB-45** offers a variety of possible uses and combines cost efficiency with minimum basic depths. The system comes with a full suite of door options; sliding, swing anti finger trap, and open in window configurations; Slide & Tilt, Side hung, bottom hung and tilt&turn. **MB-45** has been designed to provide a competitive edge to medium traffic applications across the retail, commercial and public sector markets.

perfect for indoors



**GORZÓW WIELKOPOLSKI PHILHARMONIC**

Location: Gorzów Wielkopolski / Poland / Design: BUDOPOL S.A. General construction design office



## MB-45

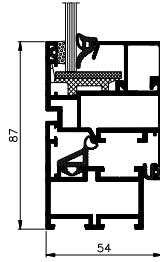

window – cross-section

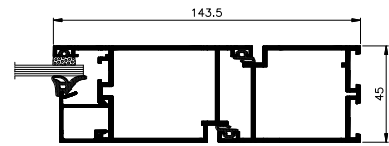

door – cross-section

Base system for use in building interiors with low thermal insulation requirements. It features large selection of profiles and accessories. It is also available as smoke proof wall partitions and doors in the class S<sub>200</sub>, S<sub>9</sub> in compliance with the norm EN 13502-2:2008.

## MB-45S

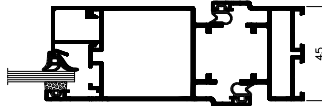

door – cross-section

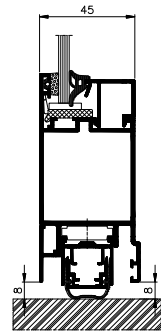

door – cross-section

The variety of main system comprising the elements of wall partitions and doors fitted with mortise hardware.

## MB-45EW

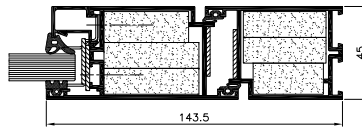

door – cross-section

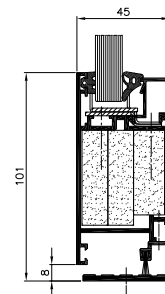

door with low-level threshold, bottom view

- possibility to use all standard types of fire resistant glass Pyroguard (EW classes)
- internal glazing – with glazing beads
- low-level threshold solution with smoke class S<sub>200</sub> & S<sub>9</sub>
- MB-45EW system certified by Efectis France



TECHNICAL SPECIFICATION	MB-45	MB-45S	MB-45D	MB-45EW
<b>PROFILES DIMENSIONS</b>				
Depth of frame (door / window)	45 mm			
Depth of leaf (door / window)	45 mm / 54 mm			
Glazing range (fixed window and door / opening window)	1.5 – 31.5 mm / 1.5 – 34 mm	1.5 – 32 mm		11 – 15.5 mm
<b>SIZE AND WEIGHT LIMITATIONS</b>				
Max. size of tilt turn window (H×W)	H to 2400 mm (1850 mm) W to 1250 mm (1600 mm)	—	—	—
Max. size of door (H×W)	H to 2400 mm (2200 mm), W to 1250 mm (1400 mm)			
Max. weight of doors / windows	120 kg / 130 kg	130 kg	120 kg	120 kg
<b>TYPES OF CONSTRUCTIONS</b>				
Solutions	Tilt window, turn window, tilt&turn window, Doors open out and open in	Mortise doors, Partition walls with doors	Doors open out and open in	One or both sides doors, solid walls in class EW30

## EXTERNAL JULIET BALCONY **MB-GLASS BARRIER**



**MB-GLASS BARRIER**-based external balustrades are used on upper floors with open-in French doors or floor to ceiling full high windows as a safety element to prevent from falling. Additionally can also help to reduce noise coming from the outside. When attached to aluminium windows, they can perfectly fit their colour. Also, they can be attached to PVC or wooden windows.

infills made of laminated, safety glass from 8.8 to 20.8 mm



Highly aesthetically appealing extremely light



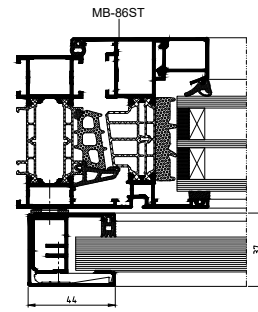

window with barrier, side view

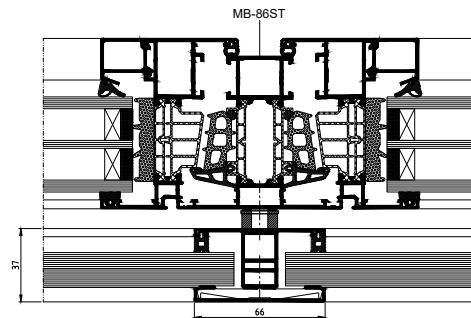

window mullion, view

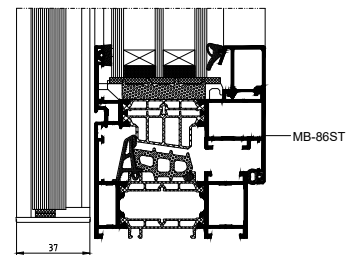

window with H-type barrier, bottom view

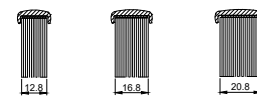

barrier, top view

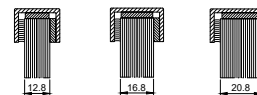

top cross-section of railing with stainless steel strips

## FEATURES AND BENEFITS

- attached directly to window profiles
- upper edge of the glass protected with aluminium or stainless-steel strip
- can be installed on single or double-leaf constructions
- glass infills increase daylighting
- infills made of bonded glass from 8.8 to 20.8 mm
- can be used in housing, offices and public facilities



## SLIDING WINDOW SYSTEM **MB-SLIDER WINDOW**

**MB-SLIDER WINDOW** is used for producing both vertical and horizontal sliding windows in internal and external applications which do not require thermal insulation. **MB-SLIDER WINDOW** can be used as reception windows in various commercial buildings, etc. Sliding window system installations are quick and easily prefabricated as they no longer need labor-intensive mechanical processing. **MB-SLIDER WINDOW** features slender leaf & frame profiles. The structural depth of window profiles is 45 mm for frame and 26 mm for leaves. One great advantage of the vertical sliding window system is that its drives are concealed in the leaf profile. This can enhance the aesthetics of a building, creating a seamless and uninterrupted view. **MB-SLIDER WINDOW** can further benefit from hardware manufactured by industry recognised companies, enabling the final appearance and functionality of the building to a high standard finish.

drive concealed in the leaf profile



Construction made functional

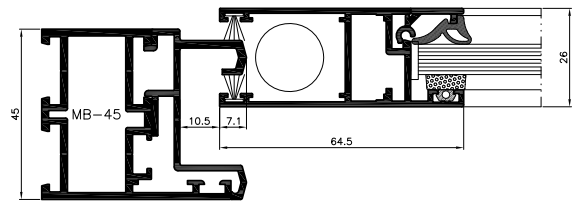

window in MB-45 system frame, view

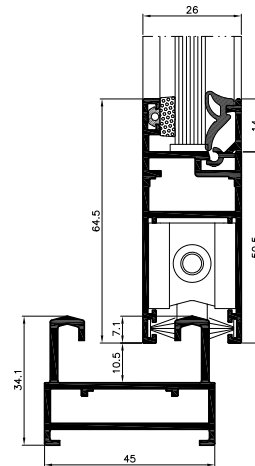

horizontally sliding window, view

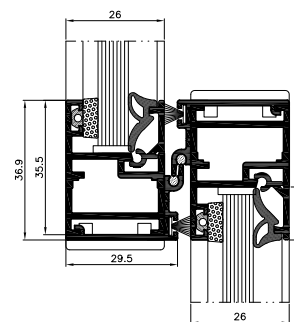

vertically sliding window, view

## FEATURES AND BENEFITS

- system-based windows can slide vertically or horizontally
- can be used with any window & door system
- maximum leaf weight in horizontal sliding window: 80 kg
- maximum active leaf weight in vertical sliding window: 25.5 kg
- drive concealed in the leaf profile
- effective water drainage & ventilation system in internal applications
- hardware by recognized companies
- two sizes of leaf profile
- reception windows can be fabricated in MB-45 system frame or as independent constructions
  - thanks to the system frame
- glazing options from 4 mm to 10.5 mm



# SLIDING DOOR

**Sliding door** systems enable fabrication of user-friendly and aesthetically looking developments that can be used effectively in interior spaces. In most cases, these constructions are MB window & door systems-based. Wide range of available solutions and potential applications: from products suitable for balcony enclosures, terraces or garden rooms to construction that are perfectly suited for public buildings and commercial buildings.

an ability of adapting in every conditions



**POLECZKI BUSINESS PARK**

Location: Warsaw / Poland / Design: RKW Rhode Kellermann Wawrowsky

## MB-SLIDE MB-SLIDE ST

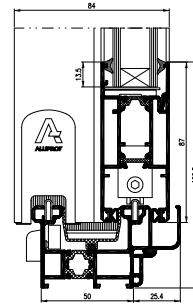

The MB-SLIDE and MB-SLIDE ST have been designed to meet the needs of users with its easy to operate functions and single or double sliding doors and windows that offer flexibility for variety of project applications. They are suitable for installation in masonry wall and aluminum facades. They can also be used as part of winter gardens and commercial windows.

## MB-DPA

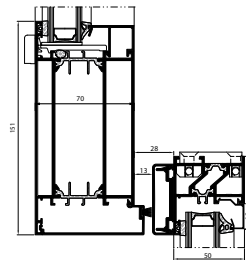

Automatic sliding door system is designed for use as individual construction, in larger glazing modules and as part of aluminum curtain wall. It can employ both thermally insulated and non insulated aluminum profiles. Offering comfort of use and high rate of safety it features large size of glazing panes.

TECHNICAL SPECIFICATION	MB-SLIDE / MB-SLIDE ST	MB-DPA
Depth of Frame (door / window)	50 and 97 mm	45, 70, 79 mm
Depth of Leaf (door / window)	37 mm	45; 70 mm
Glazing range (fixed window and opening door / window)	22 – 26 mm	1–56 mm
<b>MAX SIZE OF DOOR AND TILT TURN WINDOW</b>		
Max. size of windows (H×W)	H to 2600 mm W to 1800 mm	W to 1500 mm
Max. weight of door / window leaf	160 kg	200 kg



## A WARM AND TIGHT INSTALLATION SYSTEM **MB-INSTALLATION SOLUTION**

Energy-saving and passive buildings seek to reduce heat losses due to thermal bridges and leaky connections. But even installing highly insulated fenestration products (windows, doors) may simply be not enough. For this reason, it is recommended to install windows and balcony doors in the thermal insulation area, if possible, extended beyond the face of the wall (moved to the external insulation area of the building), and to tightly connect window and door frames to the wall. The **MB-INSTALLATION SOLUTION** ensures that this installation is carried out easily, quickly and accurately.

frame is made of 100 or 200 mm wide warm mounting beams



Window & door installation made easy and tight

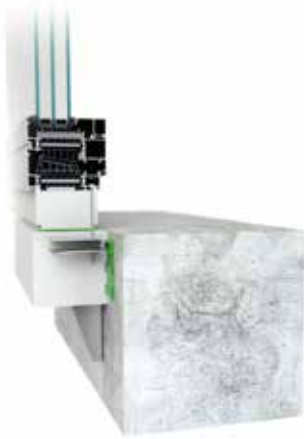

bottom connection, 100 mm beam  
with external anchor



bottom connection, 200 mm beam  
with internal anchor



top connection, with vapour-permeable tape  
and sealing adhesive



top connection,  
with jamb external profile

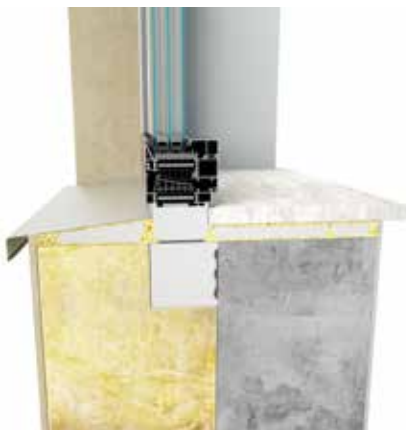

window installed in the insulation area, view

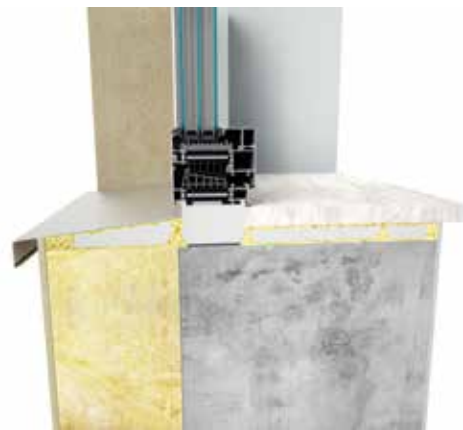

window installed in the face of the wall, view

## FEATURES AND BENEFITS

- segmented EPS-based components ensure a very low heat conductivity  $\lambda = 0.032 \text{ W}/(\text{m}^2\text{K})$
- the frame is made of 100 or 200 mm – wide warm installation beams, equipped with two types of system anchors (external or internal)
- tight & simple installation with a full set of beams, threshold bases, fasteners, foams, adhesives and sealing tapes
- for use in masonry made of hollow brick units and porotherm blocks, light concrete and limestone blocks, solid bricks, concrete and concrete hollow bricks, timber or steel framing
- can be combined with a seamless system that is based on polystyrene or wool (ETICS system) or with insulation in the wall
- allows fenestration products to be installed in the face of a wall, with bottom beam and sealed with vapour-permeable and breathable tapes

STRUCTURAL UNITISED FAÇADE  
**MB-SE85 SG**



**MENNICA LEGACY TOWER**  
 Location: Warsaw / Poland  
 Design: Goettsch Partners

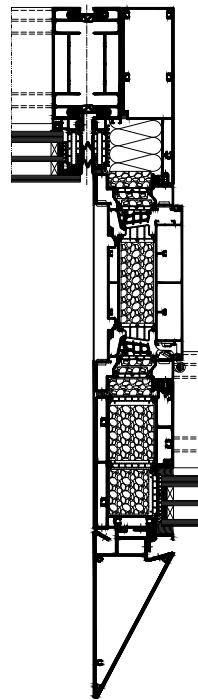

**Performance:**  
 Air Permeability: class AE  
 Watertightness: class RE 1200  
 Windload resistance: +/- 2250 Pa

cross-section of corner joints  
 90° and 270° in façade.

The ALUPROF MB-SE80 MLT unitised, mullion and transom curtain wall system is a solution originally developed for the Mennica Legacy Tower in Warsaw, one of the most prestigious developments in Poland to feature ALUPROF's systems. There are two buildings; one is one hundred and forty metres tall and the other, forty-three metres. The MB-SE80 MLT was used to build most of the surface area of the elevations for both of them.

STRUCTURAL UNITISED FAÇADE  
**MB-SE80 SG**



**LEXINGTON AVENUE**  
 Location: New York / USA  
 Design: Time Square Development

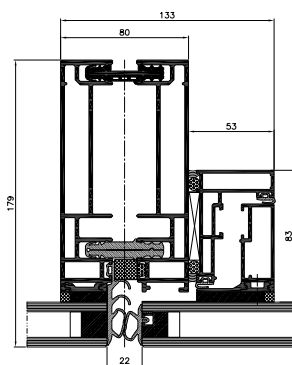

mullion and casement window  
 - cross-section

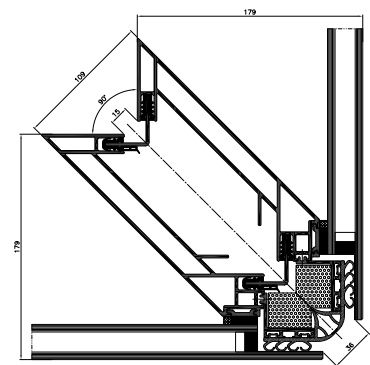

corner mullion  
 - cross-section

**Performance:**  
 Air Permeability: class AE 1200 Pa  
 Air infiltration: class RAE 1350 Pa  
 Watertightness: class RE 1500 Pa  
 Windload resistance: 1500 Pa  
 Impact resistance: class I5/E5

325 Lexington Avenue is one of the many typical high-rise buildings in New York. And it's yet another Aluprof systemsbased project in the US. The unitized curtain wall **MB-SE80 SG**, designed especially for this project is an example of a system that meets the individual needs of the project both in terms of aesthetics and technical solutions. In addition to the parameters such as the tightness of the façade, the assumed resistance to tectonic movements was also confirmed. In such cases, the structure allows a vertical movement of segments in relation to each other, this within ±5 mm.



WINDOW WITH A CONCEALED SASH

# MB-70US HI

**Performance:**

Air Permeability: class 4  
 Watertightness: class E 1050 Pa  
 Windload resistance: class C4 / B4



**ATHLETES VILLAGE**

Location: London / England  
 Design: Lifschutz Davidson Sandilands

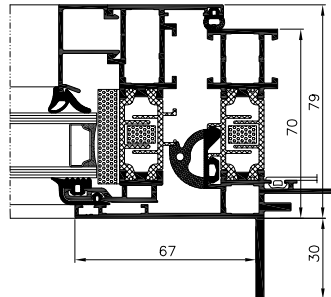

MB-70US windows  
 – cross-sections

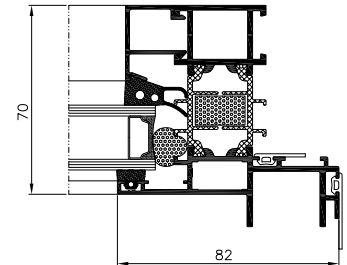

MB-70US windows  
 – cross-sections

As regards window & door systems, the requirements for the London's Athletes' Village encompassed both excellent tightness and thermal performance, as well as particular aesthetic requirements for the form of profiles and uniform appearance of its fixed and openable lites. The solution used is the **MB-70US HI** system with a hidden sash and bespoke, unique shape profiles adapted to provide perfect weatherproof joint between window frame and building structure using EPDM membrane. Additionally, bespoke profile was developed to adopt external door into concealed vent screen.

FIRE RATED SYSTEM

# MB-78EI

**Performance:**

Air Permeability: class 2  
 Watertightness: class 5A  
 Windload resistance: 2400 Pa



**GALERIA VENEDA**

Location: Łomża / Poland  
 Design: Mąka Sojka Architekci  
 in collaboration with Echo Investment

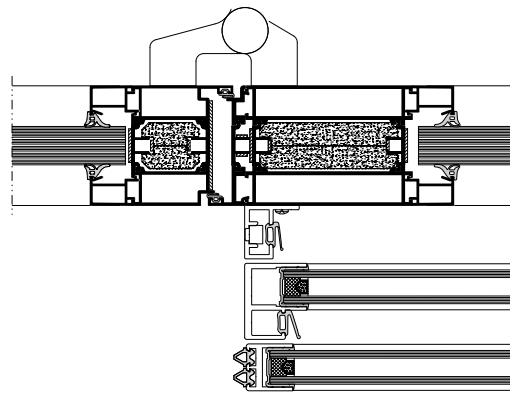

horizontal cross-section of a wall with door

Galeria VENEDA in Łomża is a shopping mall totalling app. 40K m<sup>2</sup>. As in many facilities of this type, some passages need to comply with the fire protection requirements and at the same time ensure efficient traffic. This facility utilises, among other things, the **MB-78EI** fire walls connected with telescopic sliding doors, which made it possible to optimally use the passage space in compliance with safety regulations. Such "integrated" solution was positively evaluated by the Building Research Institute, appears aesthetic and plays its role perfectly.



Download the folder  
to your device

# ALUPROF

ALUMINIUM SYSTEMS

**HEAD OFFICE ALUPROF SA**, ul. Warszawska 153, 43-300 Bielsko-Biała, Poland  
Tel.: +48 33 81 95 300, Fax: +48 33 82 20 512, e-mail: [aluprof@aluprof.eu](mailto:aluprof@aluprof.eu)

**ALUPROF UK LTD**, tel. +44 161 941 4005, e-mail: [info@aluprof.co.uk](mailto:info@aluprof.co.uk)

**ALUPROF DEUTSCHLAND GMBH**, tel. +49 421 89 81 89 0, e-mail: [Kontakt@aluprof-deutschland.com](mailto:Kontakt@aluprof-deutschland.com)

**ALUPROF SYSTEMA UKRAINA OOO**, tel. +38 044 494 47 84, e-mail: [torg@aluprof.com.ua](mailto:torg@aluprof.com.ua)

**ALUPROF HUNGARY KFT**, tel. +36 27 542 600, e-mail: [aluprof@aluprof.hu](mailto:aluprof@aluprof.hu)

**ALUPROF SYSTEM ROMANIA SRL**, tel. + 40 374 004 594, e-mail: [aluminu@aluprof.ro](mailto:aluminu@aluprof.ro)

**ALUPROF SYSTEM CZECH SRO**, tel. +420 595 136 633, e-mail: [firma@aluprof.eu](mailto:firma@aluprof.eu)

**ALUPROF NETHERLANDS B.V.**, tel. +31 49 37 69 004, e-mail: [info@aluprof-nederland.nl](mailto:info@aluprof-nederland.nl)

**ALUPROF BELGIUM**, tel. +32 52 258 110, e-mail: [belgium@aluprof.eu](mailto:belgium@aluprof.eu)

**ALUPROF USA, LLC**, tel. 1 212 687 0300, e-mail: [info@aluprofusa.com](mailto:info@aluprofusa.com)